

Mobile Digital Video Recorder User's Manual

V 1.1.0

Table of Contents

1	Features and Specifications	1
1.1	Overview	1
1.2	Function	1
1.3	Features.....	3
1.4	Specifications.....	3
2	Front Panel and Rear Panel.....	8
2.1	Front Panel.....	8
2.2	Rear Panel	9
2.2.1	Rea Panel.....	9
2.2.2	Extension Port 1	9
2.2.3	Extension Port 2	10
2.2.4	Bidirectional talk port.....	11
2.2.5	VGA port	11
2.2.6	485/CAN port	12
2.2.7	Power input port.....	13
2.3	Remote Control.....	13
2.4	Mouse Operation.....	15
3	Installation and Connections	17
3.1	Check Unpacked DVR.....	17
3.2	About Front Panel and Real Panel	17
3.3	HDD Installation.....	17
3.4	Connecting Power Supply.....	20
3.5	Connecting Audio/Video Input and Output Devices.....	20
3.5.1	Connecting Video Input	20
3.5.2	Audio Input	20
3.5.3	Audio/Video Input Switch Cable.....	20
3.6	Connecting Audio/Video Output and Output Devices.....	21
3.6.1	Connecting Video Output	21
3.6.2	Audio Output	21
3.6.3	Audio/Video Output Switch Cable.....	21
3.7	Alarm Input and Output Connection	22
3.7.1	Alarm Input and Output Details	23
3.7.2	Alarm Input Port.....	23
3.7.3	Alarm Output Port.....	24
4	Operation.....	25
4.1	Boot up& Shutdown	25
4.1.1	Boot up	25
4.1.2	Schedule Boot up & Shutdown.....	25
4.2	Startup Wizard.....	25
4.3	Login.....	26
4.4	Preview	26
4.5	Right-Click Menu	27
4.5.1	Window Switch.....	27

4.5.2	PTZ Control	28
4.5.3	Color	28
4.5.4	Search	29
4.5.5	Record Control	29
4.5.6	Alarm Output	29
4.5.7	Zero-channel encoding	29
4.6	Main Menu	29
4.7	Search & Playback	30
4.8	Information	34
4.8.1	HDD Information	34
4.8.2	BPS	36
4.8.3	Log	36
4.8.4	Version	37
4.8.5	Device	39
4.8.6	Online Users	39
4.8.7	Network Test	40
4.8.8	Network Load	40
4.9	Vehicle	41
4.9.1	3G	41
4.9.2	WIFI	42
4.9.3	G-Sensor	44
4.9.4	Register	44
4.9.5	Auto Maintenance	45
4.9.6	Abnormality	46
4.9.7	TV Adjust	47
4.10	Setting	48
4.10.1	General	48
4.10.2	Encode	50
4.10.3	Schedule	53
4.10.4	RS232	54
4.10.5	Network	55
4.10.5.1	Network Setting	56
4.10.5.2	NTP Setup	56
4.10.5.3	DDNS	57
4.10.5.4	Email	59
4.10.5.5	FTP	60
4.10.5.6	Alarm center	61
4.10.6	Alarm	62
4.10.7	Detect	64
4.10.7.1	Video Loss	64
4.10.7.2	Tampering	66
4.10.8	PTZ	66
4.10.9	Display	68
4.10.10	Default	70
4.11	Advanced	71
4.11.1	HDD Management	71

4.11.2	Alarm Output	72
4.11.3	Manual Record.....	73
4.11.3.1	Manual record menu	73
4.11.3.2	Basic operation	73
4.11.3.3	Enable/disable record	74
4.11.3.4	Enable all channel recording	74
4.11.3.5	Stop all channel recording.....	75
4.11.4	Account	75
4.11.4.1	Modify Password	76
4.11.4.2	Add/Modify Group	77
4.11.4.3	Add/Modify User	77
4.11.5	Import/Export.....	78
4.12	Backup	78
4.12.1	Detect Device.....	78
4.12.2	Backup	79
4.12.3	One key backup.....	80
4.13	Shutdown.....	80
5	WEB OPERATION.....	82
5.1	Network Connection.....	82
5.2	Login.....	82
5.3	LAN Mode.....	84
5.4	Real-time Monitor	85
5.5	PTZ.....	86
5.6	Image/Relay-out	87
5.6.1	Image	87
5.6.2	Relay output	88
5.6.3	Zero-channel encoding.....	88
5.7	WAN Login	88
5.8	Setup.....	89
5.8.1	Channel.....	89
5.8.1.1	Conditions.....	89
5.8.1.2	Video and Audio.....	91
5.8.1.2.1	Encode.....	91
5.8.1.2.2	Snapshot.....	92
5.8.1.2.3	Overlay.....	93
5.8.1.2.4	Zero-Ch Encoding.....	94
5.8.1.2.5	Preview Overlay.....	94
5.8.1.2.6	Path	95
5.8.1.3	Channel Name.....	95
5.8.2	Network.....	95
5.8.2.1	TCP/IP	95
5.8.2.2	Connection	97
5.8.2.3	DDNS	97
5.8.2.4	Email.....	99
5.8.2.5	Alarm Centre	100
5.8.3	Event	101

5.8.3.1	Video detect	101
5.8.3.1.1	Video loss.....	101
5.8.3.1.2	Tampering	102
5.8.3.2	Alarm	103
5.8.3.2.1	Local Alarm	103
5.8.3.2.2	Net Alarm.....	105
5.8.3.2.3	Alarm Out	105
5.8.4	Storage.....	106
5.8.4.1	Schedule.....	106
5.8.4.2	Storage.....	107
5.8.4.2.1	Local Storage	107
5.8.4.2.2	FTP.....	108
5.8.4.3	Record control.....	108
5.8.5	System	109
5.8.5.1	General	109
5.8.5.1.1	General.....	109
5.8.5.1.2	Date and time	110
5.8.5.2	Account	111
5.8.5.2.1	User name	112
5.8.5.2.2	Group	113
5.8.5.3	Default.....	114
5.8.5.4	Import/Export.....	115
5.8.5.5	Upgrade	115
5.8.5.6	RS232	115
5.8.5.7	PTZ.....	116
5.8.6	Information.....	117
5.8.6.1	Version	117
5.8.6.2	Log.....	117
5.8.7	Vehicle.....	118
5.8.7.1	Vehicle.....	118
5.8.7.2	WIFI.....	119
5.8.7.3	3G	119
5.8.7.3.1	CDMA/GPRS	120
5.8.7.3.2	Mobile.....	120
5.8.7.4	Auto Register	121
5.8.7.5	Auto Maintenance	121
5.8.7.6	Abnormality	122
5.8.7.7	Display	124
5.8.7.7.1	GUI	124
5.8.7.7.2	TV Adjust.....	125
5.8.7.8	Sensor	125
5.8.7.8.1	Speed.....	125
5.8.7.8.2	G-Sensor	126
5.9	Playback	126
5.10	Alarm.....	132
5.11	Log out.....	132

5.12	Un-install Web Control.....	133
6	Digital Surveillance System	134
7	FAQ	135
8	Appendix A HDD Capacity Calculation	140
9	Appendix B Compatible SATA HDD	141
	Appendix C Toxic or Hazardous Materials or Elements	142

Welcome

Thank you for purchasing our mobile digital video recorder!

This user's manual is designed to be a reference tool for your system.

Please open the accessory bag to check the items one by one in accordance with the list below.

Contact your local retailer ASAP if something is missing or damaged in the bag.

Important Safeguards and Warnings

1 . Electrical safety

All installation and operation here should conform to your local electrical safety codes. We assume no liability or responsibility for all the fires or electrical shock caused by improper handling or installation.

2 . Transportation security

Heavy stress, violent vibration or water splash are not allowed during transportation, storage and installation.

3 . Installation

Keep upwards. Handle with care.

Do not apply power to the DVR before completing installation.

Do not place objects on the DVR

4 . Qualified engineers needed

All the examination and repair work should be done by the qualified service engineers.

We are not liable for any problems caused by unauthorized modifications or attempted repair.

5 . Environment

The DVR should be installed in a cool, dry place away from direct sunlight, inflammable, explosive substances and etc.

This series product shall be transported, storage and used in the specified environments.

6. Accessories

Be sure to use all the accessories recommended by manufacturer.

Before installation, please open the package and check all the components are included.

Contact your local retailer ASAP if something is broken in your package.

7. Lithium battery

Improper battery use may result in fire, explosion, or personal injury!

When replace the battery, please make sure you are using the same model!

Before your operation please read the following instructions carefully.

- **Installation environment**

- ✧ Keep away from extreme hot places and sources;
- ✧ Avoid direct sunlight;
- ✧ Keep away from extreme humid places;
- ✧ Avoid violent vibration;
- ✧ Do not put other devices on the top of the DVR;
- ✧ Be installed in well ventilated place; do not block the vent.

- **Accessories**

Always use accessories recommend by the manufacturer.

1 Features and Specifications

1.1 Overview

This series mobile DVR is developed based on our latest high definition display platform. It max supports 8-channel 960H resolution. It adopts popular H.264 algorithm and has high encode efficiency. During 2048Kbps bit stream, the playback resolution can reach 300TVL or higher which greatly saves the storage space.

In the view of the network application, some series product can support the 3G network module capability. At the same time, in order to be suitable for the wireless network transmission, it adopts the optimized network transmission, built-in positioning module to establish a wireless video monitor management system to realize remote management and real-time surveillance.

This series product also adopts the professional mobile design, low power consumption, no fan construction, standardized dimension. The wide voltage power supplying supports various applications. The unique anti-vibration removable HDD box design makes it easier to backup and manage the record.

This series product can be widely used in various areas such as public transportation, long-distance bus, public security patrol, cash truck, dangerous object transportation, logistics transportation and etc. It can also be used in many environments which has high requirement for the video monitor.

Important

Please note, GPS, 3G and WIFI function are optional.

- **Only the unit of GPS module supports GPS function.**
- **Only the unit of 3G module supports 3G function.**
- **Only the unit of WIFI module supports WIFI function**

1.2 Function

Slight difference may be found due to different series products.

- **Storage function**

Special data format to guarantee data security and can avoid vicious data modification.

- **Compression format**

Support multiple-channel audio and video signal. An independent hardware decodes the audio and video signal from each channel to maintain video and audio synchronization.

- **Backup function**

Support backup operation via USB port (such as flash disk, portable HDD)

eSATA backup device (Such as eSATA portable HDD), support high-speed backup via eSATA port.

Support one Micro SD card backup (For product of Micro SD card HDD box series only.).

Client-end user can download the DVR file to local HDD to backup via network.

- **Record playback function**

Support each channel real-time record independently, and at the same time it can support forward play, network monitor, record search, download and etc.

Support various playback modes: slow play, fast play, backward play and frame by frame play.

Support time title overlay so that you can view event accurate occurred time

Support specified zone enlargement.

- **Network operation**

Support network remote real-time monitor, remote record search and remote PTZ control.

- **Alarm activation function**

Six-channel level alarm inputs can connect to door signal, turn-light signal, brake signal to prompt and record.

One channel pulse alarm input to connect to vehicle speed sensor.

Two-channel analog on-off signal (level) alarm input, support analog signal alarm.

One channel relay on-off output, one channel level alarm output to realize convenient alarm activation.

The alarm input port and output port has the protection circuit to guarantee device safety.

- **Communication port**

Three RS232 ports, one general 232 port can connect to peripheral keyboard, computer COM port, matrix control and etc. Two special RS232 port to connect to specified peripheral devices.

Standard 1000Mbps Ethernet port can realize network access function.

- **Intelligent operation**

Mouse operation function

In the menu, support copy and paste setup function

- **GPS positioning**

The GSP information can activate the record function while the search function can activate the vehicle movement track.

Please note only the unit of GPS module supports this function.

- **3G network**

Latest wireless network communication technology allows you to easily control the device.

Please note only the unit of 3G module supports this function.

- **Removable HDD design**

The professional removable anti-vibration design supports fix and removable operation and can connect to PC USB port to realize fast and convenience data backup.

- **One-button operation**

You can click just one button to realize record backup, program upgrade, which makes it suitable for the daily maintenance and operation in the vehicle.

- **Dual-stream**

Considering the wireless network band is small and the network is not stable, system adopts the dual stream to implement real-time record and network transmission independently, which greatly optimizes the network transmission encode code and enhance the wireless network control compatibility.

- **Zero-channel encode**

The device support zero-channel encode function. It can realize all-channel video synchronization transmission when there are high fluency requirements.

- **Rollover and collision detect**

Built-in G-sensor support rollover and collision detect. It can send out an alarm via the platform.

1.3 Features

- **Extra low power consumption**

Low power consumption design can greatly reduce the accumulator load and make the circuit safer. (It is also very meaningful when you use the latch record function. During the latch record function, the device needs to use the power from the accumulator. If the power is too high, it may result in accumulator safety problem.)

- **Mobile vehicle power**

Professional wide power supplying design (6-36V) for vehicle use. It is suitable for various voltages. It has overload protection, under voltage protection, short circuit protection and overflow protection.

- **High anti-vibration design**

The unique HDD box adopts built-in anti-vibration design. It adopts the mechanical anti-vibration, electronic anti-vibration and patent software anti-vibration together to realize the multiple-level anti-vibration mechanism.

- **Non-fan design**

The non-fan design realizes quiet environment, free from dust and water and at the same time, it achieves the low power consumption and sound ventilation. This design meets the contemporary high-end electronic device development tendency.

Slight function differences may be found due to different series.

1.4 Specifications

	Parameter	4-channel real-time 960H series	8-channel real-time 960H series
System	Main Processor	High-performance industrial embedded micro controller	
	OS	Embedded LINUX	
	System Resources	Multiplex operations: Multiple-channel record, multiple-channel playback and network operation simultaneously	
	Interface	User-friendly graphical user interface	
	Input Devices	USB mouse, remote control	

	Input Method	Arabic number, English character, donation and extension Chinese (optional)	
Compression Standard	Video Compression	H.264	
	Audio Compression	G.711A	
Video monitor	Video Input	4/8-ch composite video input: (NTSC/PAL) aviation port (1.0V _{P-P} , 75Ω)	
	Video Output	2-ch PAL/NTSC composite aviation-port(1.0VP- P, 75Ω). 1-ch VGA output. Support TV/VGA video output at the same time.	
	Video Standard	PAL (625 line, 50f/s), NTSC (525 line, 60f/s)	
	Record Speed	Real-time mode: PAL 1f/s to 25f/s per channel and NTSC 1f/s to 30f/s per channel	
	Video Partition	1/4 windows(Optional)	1/4/9 windows(Optional)
	Monitor Touring	Support monitor tour functions such as alarm and schedule auto control.	
	Resolution (PAL/NTSC)	PAL/NTSC	
		Playback: All-channel supports: 25/30fps 960H 960×576/ 960×480, D1 704×576/704×480, CIF 352×288/ 352×240 , QCIF 176×144/176×120	
	Image Quality	Extra stream: CIF 352×288/ 352×240, QCIF 176×144/176×120	
		6-level image quality (Adjustable)	
	Privacy mask	Support one privacy mask of user-defined size in full screen. Support max 4 zones.	
	Image Information	Channel information, time information, GPS information, plate information, and privacy mask zone. Please note only the unit of GPS module supports GPS information overlay function.	
	TV Adjust	Adjust TV output zone suitable to anamorphic video.	
Channel Lock	Cover secret channel with blue screen though system is encoding normally. Screen-lock function to prevent unauthorized user seeing secret video.		
Channel Information	Channel name, recording status, screen lock status, and video loss status are shown on the screen.		
Color Configuration	Hue, brightness, contrast, saturation and gain setup for each channel.		
Audio	Audio Input	4-ch audio input 200 mV-1000mV 10KΩ (aviation port).	8-ch audio input 200 mV-1000mV 10KΩ (aviation port).

	Audio Output	2-ch aviation port audio output 200mV-3000mV 5K.
	Bidirectional Talk	1-ch active MIC input. 1-ch Line out output.
	Handset microphone	Support audio talk function. Support one-button talk function. Please note it works with handset microphone and it is for special and applications.
Hard disk	Hard Disk	2 built-in SATA port. Support 2 HDDs.
	Hard Disk Occupation	Audio: 28.8MByte/h Video: 56-900MByte/h
	Recording Mode	Manual recording, schedule recording and alarm recording Priority: Manual recording> alarm recording>schedule recording.
	Recording Length	1 to 120 minutes single record duration (Default setup is 60 minutes)
	Playback Repeat Way	When hard disk is full, system can overwrite previous video file.
	Record Search	Various search engines such as time, type and channel.
	Playback Mode	Various fast play, slow play speeds, manual frame by frame playback and reverse play mode.
	Various File Switch Ways	Can switch to previous or next file or any file in current play list. Can switch to file on other channel of the same time. (If there is a file) Support file continuous play, when file is end system auto plays the next file in the current channel
	Multi-channel Playback	4-ch playback mode.
	Window Zoom	Switch between self-adaptive screen/full screen when playback
	Partial Enlargement	When in one-window full-screen playback mode, you can select any zone to activate partial enlargement function.
Backup function	Backup Mode	Support general HDD backup.
		Support peripheral USB backup device. (Flash disk, portable disk and etc.)
		Support Micro SD card backup.
		External connected ESATA HDD backup.
		Support network download and backup
Network Function	Network Control	View monitor channel remotely.
		DVR configuration through client-end and web browser
		Upgrade via client or browser to realize remote maintenance.
		View alarm information such as external alarm, video loss via network.
		Support network PTZ control
		File download, backup and playback remotely
		Multiple devices share information via corresponding software such as professional surveillance software (PSS)
		Duplex transparent COM

		Network alarm input and output	
		Bidirectional audio.	
	Wireless Network		Support SMS function.
			Support auto connection function
			Support network type and parameter setup.
		Support network signal status indication function	
Alarm	Video Loss	Alarm can activate external alarm output or screen message prompt. The alarm responding time is less than 5 seconds.	
	Pre-record	The alarm activation pre-record time ranges from 5 to 30 seconds.	
	External Alarm	Support record activation function or activate external alarm or screen message in specified period.	
	Manual Alarm Control	Enable or disable alarm input channel Support analog alarm signal to specific alarm output channel.	
	Alarm Input	7-ch alarm input. The 1/2/3/4/5/6-channel is valid at low level (NO/NC). The 7 th channel is pulse alarm (Frequency is below 200Hz.)	
	Alarm Output	2-channel relay output. The 1 st channel is level output. The 2 nd channel is relay output.	
	Alarm Relay	30VDC 1A, 125VAC 0.3A (activation alarm)	
Interface	USB Interface	2 USB 2.0 ports.	
	Network connection	RJ45 10M/100M/1000Mbps self-adaptable Ethernet port	
	RS232	One general RS232 COM (Debug),keyboard connection and transparent serial port(COM input and output via network) Connect to the peripheral low-speed device. COM hand shaking function supported.	
Extension Function	GPS	Built-in GPS module. Realize GPS information display, and encode overlay, record. Please note only the unit of GPS module supports GPS function.	
	WIFI	Built-in WIFI module. Please note only the unit of WIFI module supports GPS function.	
	3G	Built-in 3G module(EV-DO, WCDMA, TD-SCDMA), support period setup, and message activate online or offline, audio activate online or offline, alive time setup. Please note only the unit of 3G module supports 3G function.	
System Information	Hard Disk Information	Display HDD current status.	
	Data Stream Statistics	Data stream statistics for each channel (in wave mode)	
	Log statistics	Backup to 1024 log files. Support various search engines such as time and type.	
	Version	Display version information: channel amount, alarm input and output amount, system version and release date.	

	On-line user	Display current on-line user
User Management	User Management	Multi-level user management; various management modes. Integrated management for local user, serial port user and network user. Configurable user right.
		Support user /group and its corresponding rights modification.
	Password Authentication	Password modification Administrator can modify other user's password.
		Account lock strategy Five times login failure in thirty minutes may result in account lock. It is to lower the risk of the system attack.
Upgrade		Client-end or update tool. Extension USB device
Login, Logout and Shutdown		Password login protection to guarantee safety User-friendly interface when logout. Provide the following options: Logout /shutdown/ restart. Right authentication when shut down to make sure only those proper people can turn off DVR
General Parameters	Power	DC 12V/24V operation environment. The voltage ranges from DC +6V to +36V. Self-adaptive voltage, the negative end is grounded. DC 12V: Max 11.1A current. DC 24V: Max 5.6A current.
	Power Consumption	<15W (Exclude HDD)
	Working Temperature	-10°C to +70°C Please use heating module (optional) if the HDD is used in the extreme cold environments.
	Working Humidity	10%—90%
	Air Pressure	86kpa—106kpa
	Dimension (W×H×L)	202×91×252(Unit:mm)
	Weight	3.5Kg
	Installation Mode	Rack installation

2 Front Panel and Rear Panel

2.1 Front Panel

The front panel is shown as in Figure 2-1.

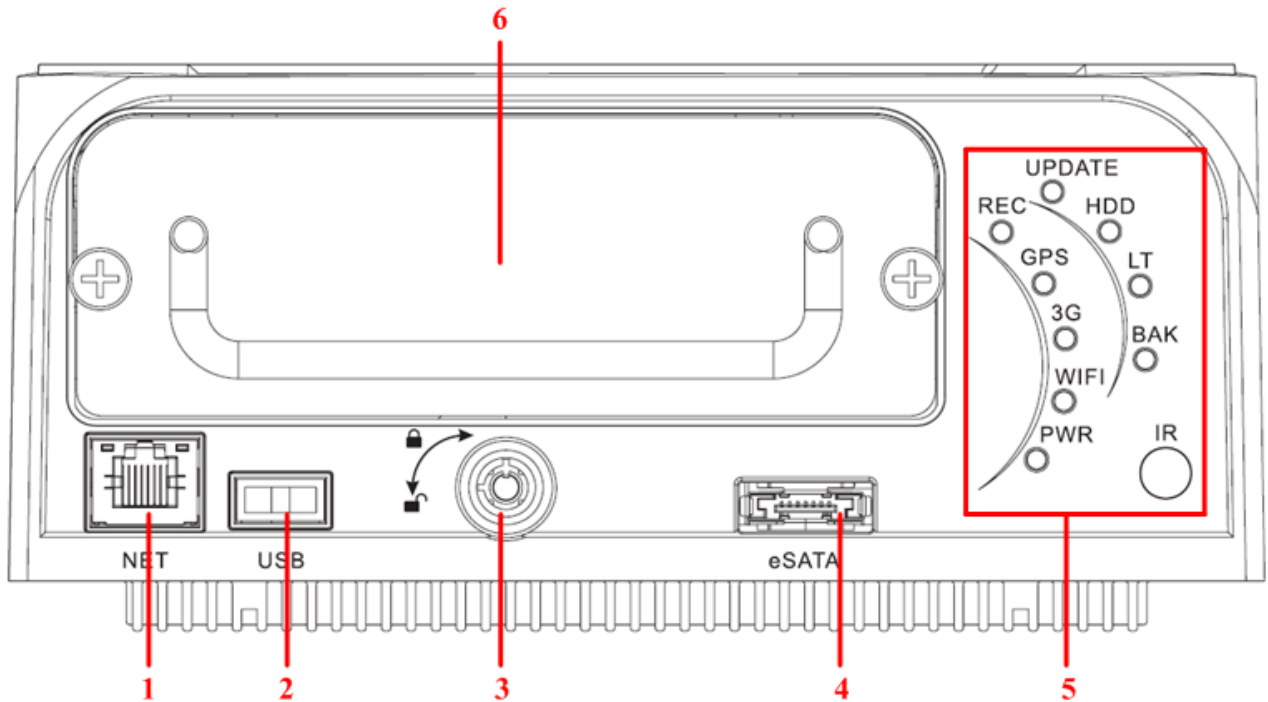

Figure 2-1

Please refer to the following sheet for detailed information.

SN	Name	Port and Indicator Light
1	NET	RJ45 port
2	USB	USB2.0 port
3	Locker	Turn clockwise to lock HDD box, turn counter clockwise to unlock HDD box.
4	eSATA	eSATA data port. Connect to eSATA portable HDD and etc. Support high-speed data backup via eSATA port.
5	REC	Record indicator light.
	GPS	Positioning indicator light.
	3G	3G indicator light
	WIFI	WIFI indicator light
	PWR	Power indicator light
	UPDATE	Update indicator light
	HDD	HDD indicator light
	LT	Low temperature working indicator light
	BAK	Backup indicator light
	IR	IR receiver
6	HDD box	Please refer to chapter 3.3.

2.2 Rear Panel

2.2.1 Rea Panel

This series product supports AV output and VGA output at the same time.

The rear panel is shown as in Figure 2-2.

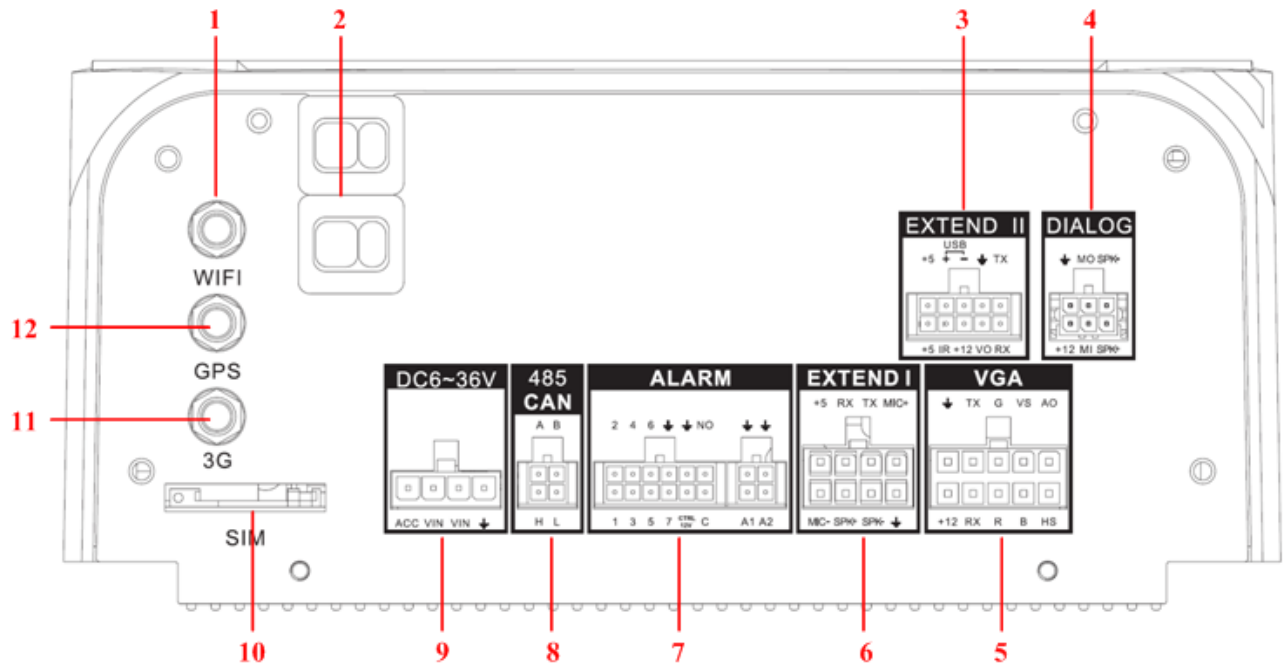

Figure 2-2

Please refer to the following sheet for front panel button information.

SN	Name	Note
1	WIFI	WIFI antenna port
2	-	Audio/video input and output cable.
3	EXTEND II	Extension port 2
4	DIALOG	Bidirectional talk port
5	VGA	VGA port
6	EXTEND I	Extension port 1
7	ALARM	Alarm input/output port
8	485 CAN	485/CAN port
9	Power input port	DC 12V/24V operation environment.
10	SIM	SIM card slot
11	3G	3G antenna port
12	GPS	GPS antenna port

2.2.2 Extension Port 1

The following contents are to introduce function of each port. You can make connection cable by yourself or you can contact your local retailer to purchase.

The extension port1 is shown as in Figure 2-3.

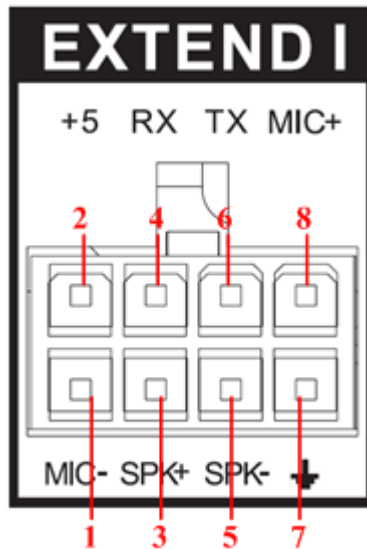

Figure 2-3

Please refer to the following sheet for detailed information.

SN	Function
1	Mic negative
2	+5V input
3	Speak positive
4	RS232 TX
5	Speak negative
6	RS232 RX
7	GND
8	Mic positive

2.2.3 Extension Port 2

The following contents are to introduce function of each port. You can make connection cable by yourself or you can contact your local retailer to purchase.

The extension port2 is shown as in Figure 2-4.

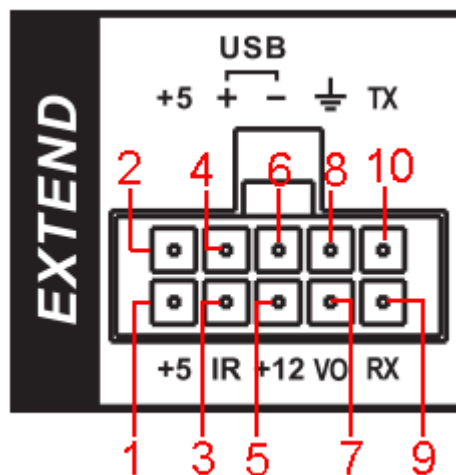

Figure 2-4

Please refer to the following sheet for detailed information.

SN	Function
1	+5V output
2	USB 5V
3	IR receiver
4	USB data+
5	+12V output
6	USB data-
7	AV video output
8	GND
9	232 RX
10	232 TX

2.2.4 Bidirectional talk port

The following contents are to introduce function of each port. You can make connection cable by yourself or you can contact your local retailer to purchase.

The bidirectional talk port is shown as in Figure 2-5.

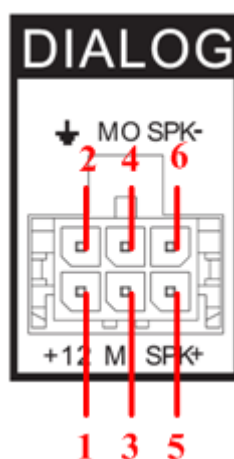

Figure 2-5

Please refer to the following sheet for detailed information.

SN	Function
1	+12V output
2	GND
3	Mic In
4	Mic Out
5	Speak positive
6	Speak negative

2.2.5 VGA port

The following contents are to introduce function of each port. You can make connection cable by yourself or you can contact your local retailer to purchase.

The VGA port is shown as in Figure 2-6.

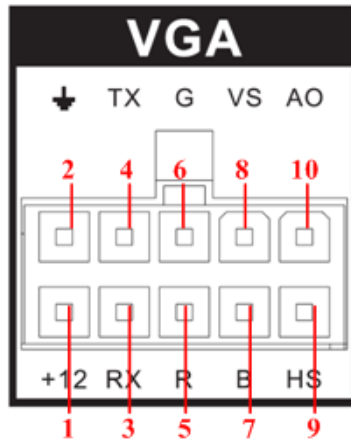

Figure 2-6

Please refer to the following sheet for detailed information.

SN	Name	Pin Introduction
1	+12V	+12V output
2	⚡	GND
3	RX	232 RX
4	TX	232 TX
5	R	VGA signal Red
6	G	VGA signal Green
7	B	VGA signal Blue
8	VS	VGA signal field sync.
9	HS	VGA signal line sync.
10	AO	AV signal video output

2.2.6 485/CAN port

The following contents are to introduce function of each port. You can make connection cable by yourself or you can contact your local retailer to purchase.

The 485/CAN port is shown as in Figure 2-7.

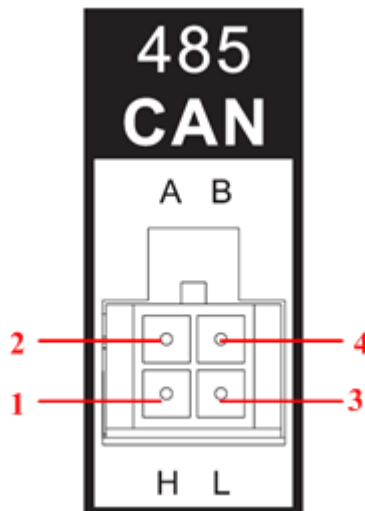

Figure 2-7

Please refer to the following sheet for detailed information.

SN	Function
1	CAN_H
2	485_A
3	CAN_L
4	485_B

2.2.7 Power input port

This series product adopts built-in power supplying design.

The power input port is shown as in Figure 2-8.

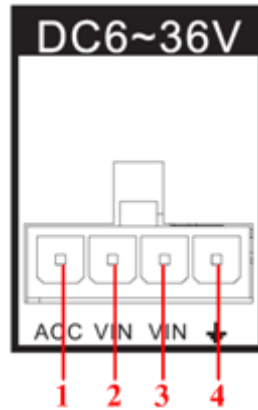

Figure 2-8

Please refer to the following sheet for detailed information.

SN	Name	Pin Color	Pin Introduction
1	ACC	Red	ACC signal input
2	VIN	-	Power positive input (Reserved)
3	VIN	Yellow	Power positive input
4	⊕	Black	GND

2.3 Remote Control

The remote control interface is shown as in Figure 2-1.

Please note remote control is not our standard accessory and it is not included in the accessory bag.

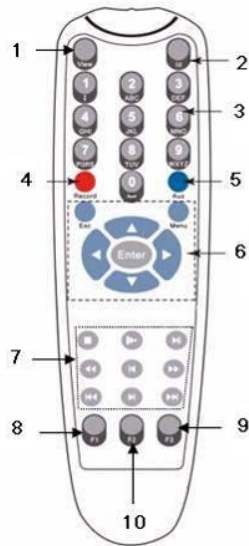

Figure 2-1

Serial Number	Name	Function
1	View	Switch window
2	ID	Click it to input device serial number, so that you can control it.
3	Number 0 to 9	Input password, channel or switch channel.
4	Record	Record
5	Aux	Auxiliary button
6	Enter	Confirm button
	Menu	Menu button
	Esc	Cancel button
	▲ ◀ ▶ ▼	Direction buttons Direction buttons in PTZ. Control.
7	■	Stop button Zoom out button in the PTZ control
	▶	Slow play
	▶ II	Playback/pause Zoom in button in the PTZ control
	◀◀	Backward
	◀	Previous
	▶▶	Forward
	◀◀	Various slow play speed and normal speed play. Focus (-) button in the PTZ control.

	▶	Next
	▶▶	Various fast play speeds and normal play speed. Focus (+) button in the PTZ control.
8	F1	Shortcut button to backup
9	F2	Reserved for future use.
10	F3	Reserved for future use.

2.4 Mouse Operation

Please refer to the following sheet for mouse operation instruction.

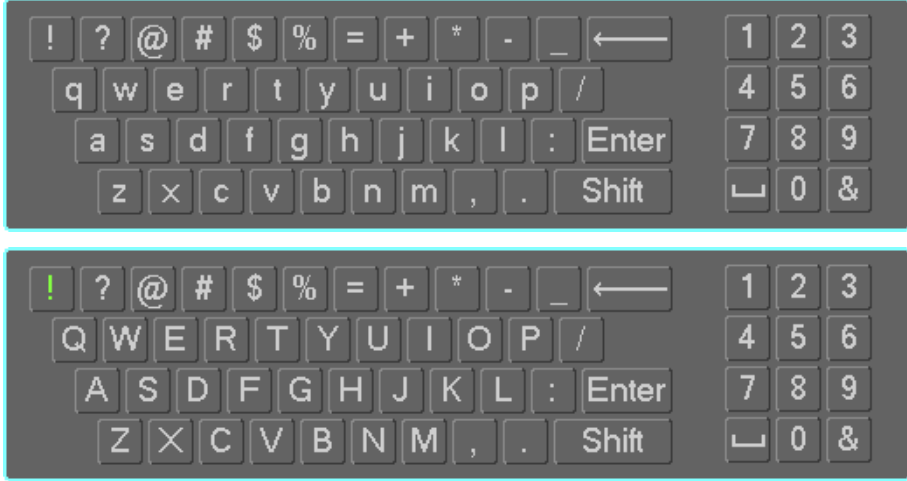
Left click mouse	When you have selected one menu item, left click mouse to view menu content.
	Modify checkbox
	Click combo box to pop up dropdown list
	In input box, you can select input methods. Left click the corresponding button on the panel you can input numeral/English character (small/capitalized). Here ← stands for backspace button. _ stands for space button. In English input mode: _ stands for input a backspace icon and ← stands for deleting the previous character.
	
	In numeral input mode: _ stands for clear and ← stands for deleting the previous numeral.
Double left click mouse	Implement special control operation such as double click one item in the file list to playback the video.
	In multiple-window mode, double left click one channel to view in full-window. Double left click current video again to go back to previous multiple-window mode.
Right click mouse	In real-time monitor mode, pops up shortcut menu.
	Exit current menu without saving the modification.
Press middle	In numeral input box: Increase or decrease numeral value.
	Switch the items in the check box.

button	Page up or page down
Move mouse	Select current control or move control
Drag mouse	Select privacy mask zone.

3 Installation and Connections

Note: All the installation and operations here should conform to your local electric safety rules.

3.1 Check Unpacked DVR

When you receive the DVR from the forwarding agent, please check whether there is any visible damage. The protective materials used for the package of the DVR can protect most accidental clashes during transportation. Then you can open the box to check the accessories.

Please check the items in accordance with the list (Remote control is optional). Finally you can remove the protective film of the DVR.

Note

Remote control is not a standard accessory and it is not included in the accessory bag.

3.2 About Front Panel and Rear Panel

For detailed information of the function keys in the front panel and the ports in the rear panel, please refer to the appendix for detailed information.

The model in the front panel is very important; please check according to your purchase order.

The label in the rear panel is very important too. Usually we need you to represent the serial number when we provide the service after sales.

3.3 HDD Installation

The unit you received has no HDD. Please remove the HDD box from the device and then follow the steps listed below to install. Please refer to the appendix for compatible HDD brand.

1) The HDD box and the parts are shown as below. See Figure 3-1. Please loosen the bolts of front panel and rear panel of the HDD box and then remove the top cover of the HDD box.

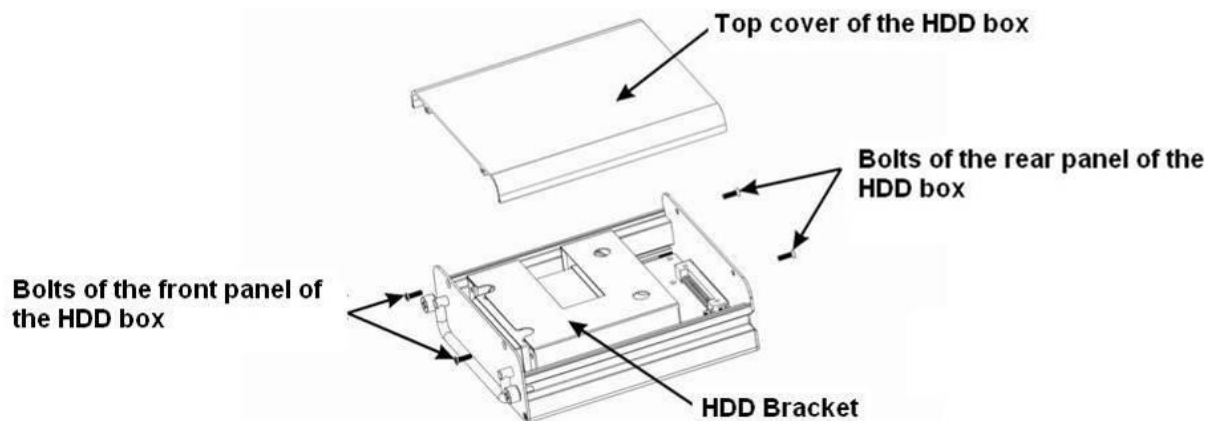

Figure 3-1

2) Now you can see an interface shown as in Figure 3-2. Remove the four bolts from the HDD bracket and then take out the bracket from the HDD box. Pull out the cable from the cable exit.

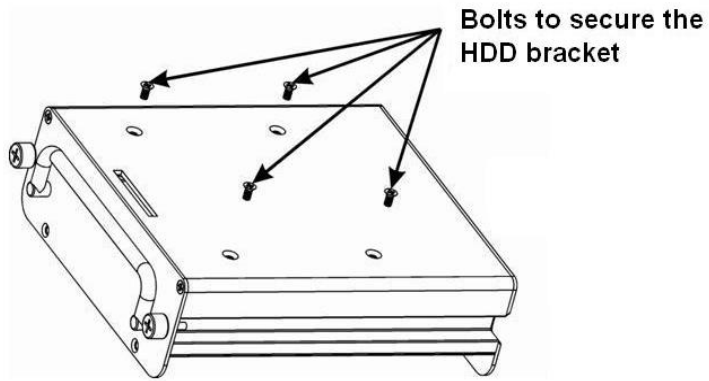

Figure 3-2

3) Now you can see an interface shown as in Figure 3-3 after you took out the bracket. Remove the bolts from the HDD bracket and then take out the HDD PCB board.

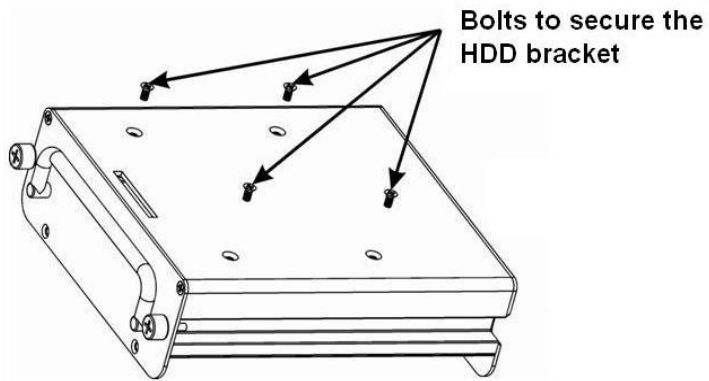

Figure 3-3

4) Take HDD PCB and HDD and follow the direction shown as in Figure 3-4 to insert.

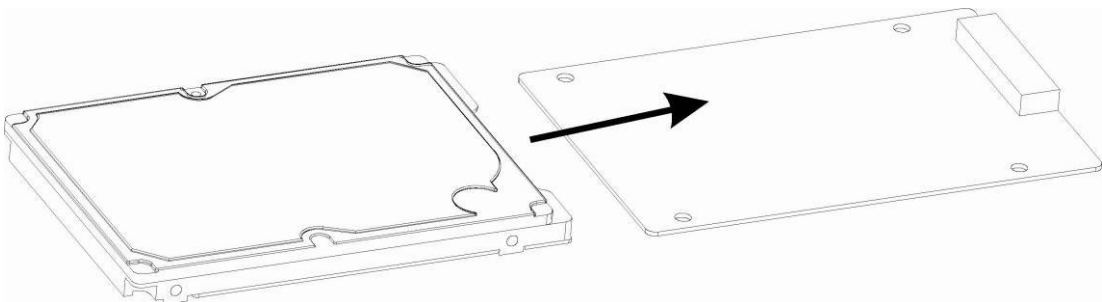

Figure 3-4

5) After put the HDD PCB and HDD to the HDD bracket, please secure the bolts to fix the HDD. See Figure 3-5.

Bolts to secure the HDD

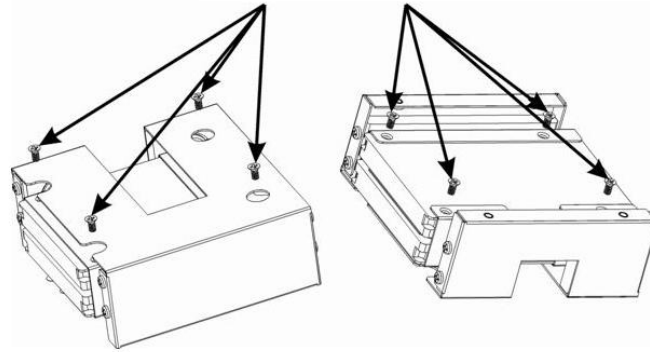

Figure 3-5

6) After install the HDD, put the HDD bracket back to the box. See Figure 3-6. Secure bolts of the HDD bracket and connect the cable to the corresponding ports.

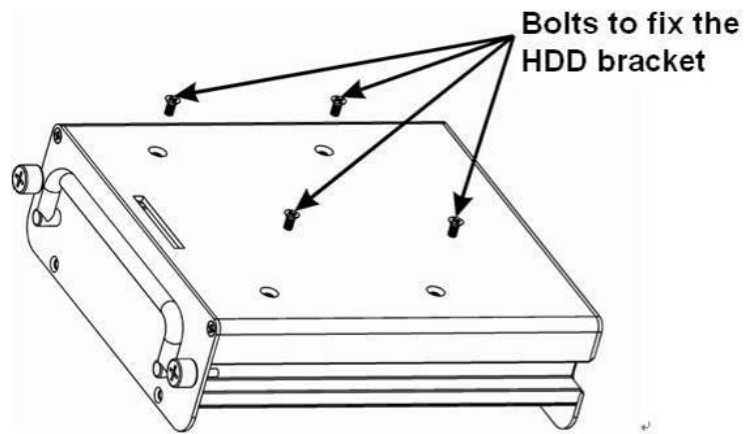

Figure 3-6

7) After you installed the HDD bracket. Please refer to Figure 3-7 to put the HDD box top cover back and secure the bolts of the front panel and rear panel of the HDD box. Now the HDD installation is complete.

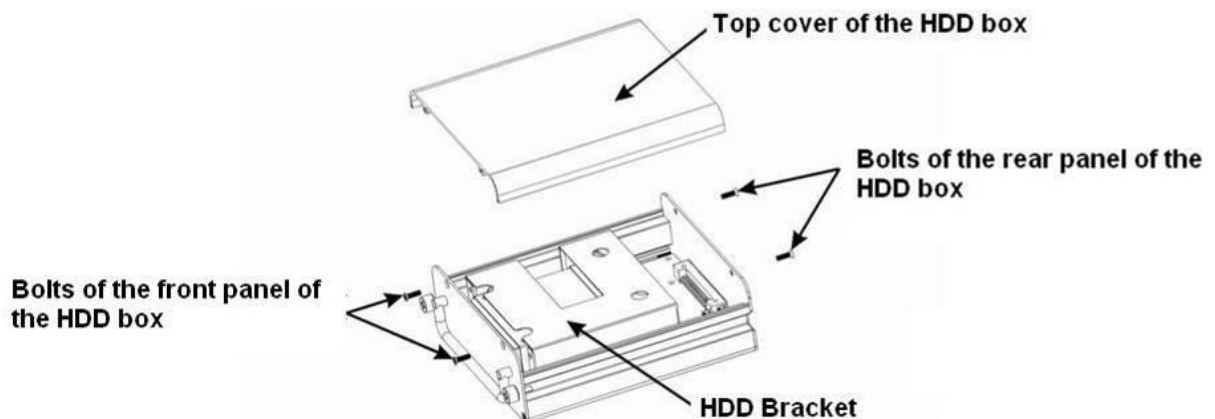

Figure 3-7

3.4 Connecting Power Supply

Please check input voltage and device power button match or not.

We recommend you use UPS to guarantee steady operation, DVR life span, and other peripheral equipments operation such as cameras.

3.5 Connecting Audio/Video Input and Output Devices

3.5.1 Connecting Video Input

The input video format includes: composite signal PAL/NTSC 1.0V_{P-P} 75Ω.

The video signal should comply with your national standards.

The input video signal shall have high SNR, low distortion; low interference, natural color and suitable lightness.

Guarantee the stability and reliability of the camera signal:

The camera shall be installed in a cool, dry place away from direct sunlight, inflammable, explosive substances and etc.

The camera and the DVR should have the same grounding to ensure the normal operation of the camera.

Guarantee stability and reliability of the transmission line.

Please use high quality, sound shielded BNC. Please select suitable BNC model according to the transmission distance.

If the distance is too long, you should use twisted pair cable, and you can add video compensation devices or use optical fiber to ensure video quality.

You should keep the video signal away from the strong electromagnetic interference, especially the high tension current.

Keep connection lugs in well contact.

The signal line and shielded wire should be fixed firmly and in well connection. Avoid dry joint, lap welding and oxidation.

3.5.2 Audio Input

Due to high impedance of audio input, please use active sound pick-up.

Audio transmission is similar to video transmission. Try to avoid interference, dry joint, loose contact and it shall be away from high tension current.

3.5.3 Audio/Video Input Switch Cable

Please use the following audio/video input cable if your camera port is BNC.

Please refer to Figure 3-8 for 4-pin aviation port cable information.

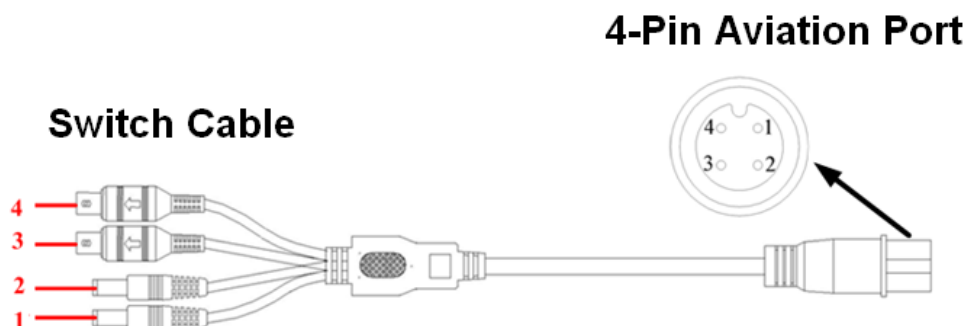

Figure 3-8

Please refer to the following sheet for detailed information.

Socket	Switch cable color and definition
1	DC power male socket. External is negative and internal is positive. (Camera power)
2	DC power male socket. External is negative and internal is positive. (Camera power)
3	Yellow BNC male port (Video input)
4	White BNC male port (Audio input)

Port	4-pin aviation port
1	12V external camera power
2	GND
3	Audio
4	Video

3.6 Connecting Audio/Video Output and Output Devices

3.6.1 Connecting Video Output

Video output includes a BNC(PAL/NTSC1.0V_{P-P} , 75Ω) output ,a VGA output. System supports BNC and VGA output at the same time.

When you are using pc-type monitor to replace the monitor, please pay attention to the following points:

- To defer aging, do not allow the pc monitor to run for a long time.
- Regular demagnetization will keep device maintain proper status.
- Keep it away from strong electromagnetic interference devices.

Using TV as video output device is not a reliable substitution method. You also need to reduce the working hour and control the interference from power supply and other devices. The low quality TV may result in device damage.

3.6.2 Audio Output

The audio output signal parameter is usually over 200mv 1KΩ (BNC). It can directly connect to low impedance earphone, active sound box or amplifier-drive audio output device.

If the sound box and the pick-up cannot be separated spatially, it is easy to arouse squeaking. In this case you can adopt the following measures:

- Use better sound pick-up with better directing property.
- Reduce the volume of the sound box.
- Using more sound-absorbing materials in decoration can reduce voice echo and improve acoustics environment.
- Adjust the layout to reduce happening of the squeaking.

3.6.3 Audio/Video Output Switch Cable

Audio/video output cable is shown as below. See Figure 3-9. You can use it when your monitor port is general BNC port.

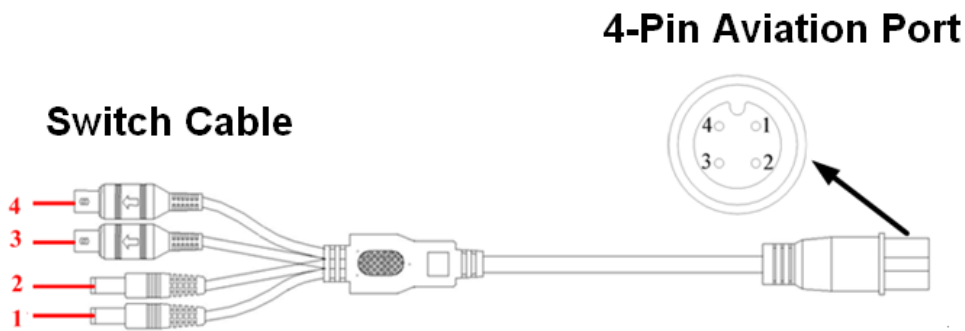

Figure 3-9

Please refer to the following sheet for detailed information.

Socket	Switch cable color and definition
1	DC power male socket. External is negative and internal is positive. (Camera power)
2	DC power male socket. External is negative and internal is positive. (Camera power)
3	Yellow BNC male port (Video input)
4	White BNC male port (Audio input)

Port	4-pin aviation port
1	12V external camera power
2	GND
3	Audio
4	Video

Note

For some special series products, you need contact your local retailer for additional audio/video output cable.

3.7 Alarm Input and Output Connection

There are two alarm input types for you to select: normal open (NO) and normal close (NC).

1. Alarm input

- a. Alarm input 1-6 supports grounding alarm input.
- b. Alarm input 1-6 supports 12V-24V voltage signal alarm input.
- d. Alarm input 7 supports pulse input. The frequency is less than 200Hz and voltage is lower than 24V.
- c. When the alarm device is connecting one DVR and one other device, please use a relay to separate them,

2. Alarm output

The alarm output port 1 is level input. Output voltage is 12V and the max load shall be less than 12V/1A. It should not be connected to high power load directly to avoid high current which may result in relay damage. Please use the co contactor to realize the connection between the alarm output port and the load.

The alarm output 2 is relay output.

3. Analog signal output

Support 2-channel analog signal level input. <0}

4. Please make sure the front-end device has soundly earthed.

Improper grounding may result in chip damage.

3.7.1 Alarm Input and Output Details

Alarm input and output interface is shown as in Figure 3-10.

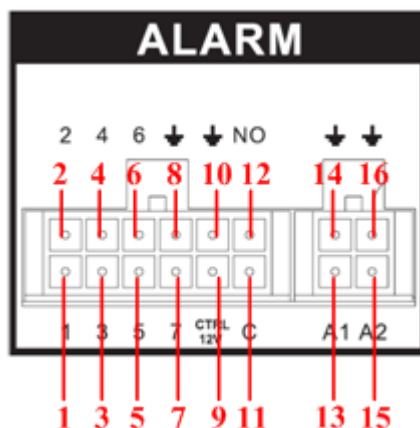

Figure 3-10

Please refer to the following sheet for detailed information.

SN	Name	Pin Introduction
1	1	Alarm input 1
2	2	Alarm input 2
3	3	Alarm input 3
4	4	Alarm input 4
5	5	Alarm input 5
6	6	Alarm input 6
7	7	Alarm input 7
8	⊕	GND
9	CTRL 12V	Alarm output 1
10	⊕	GND
11	C	Alarm output 2
12	NO	Alarm output 2
13	A1	Analog signal input 1
14	⊕	Analog signal input 1 GND
15	A2	Analog signal input 2
16	⊕	Analog signal input 2 GND

3.7.2 Alarm Input Port

Please refer to the following sheet for more information. See Figure 3-11.

- Normal open or Normal close type.
- Please parallel connect COM end and COM end of the alarm detector (Provide external power to the alarm detector).
- Please parallel connect the Ground of the DVR and the ground of the alarm detector.

- Please connect the NC port of the alarm sensor to the DVR alarm input(ALARM)
- Use the same ground with that of DVR if you use external power to the alarm device.

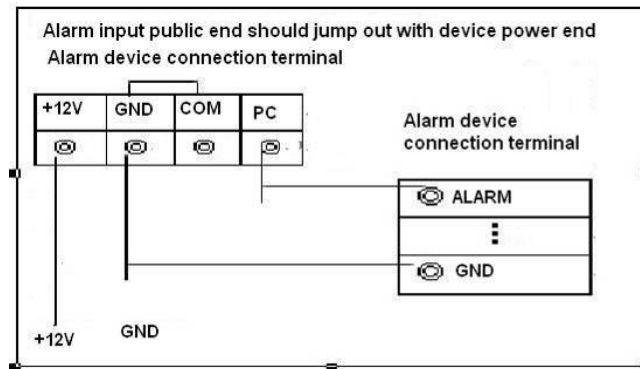

Figure 3-11

3.7.3 Alarm Output Port

- Alarm output 1 is level input, output voltage is 12V. The max load shall be less than 12V/1A. It should not be connected to high power load directly to avoid high current which may result in relay damage. Please use the co contactor to realize the connection between the alarm output port and the load.
- Alarm output 2 is on-off alarm output (NO contact). Provide external power to external alarm device.
- To avoid overloading, please read the following relay parameters sheet carefully.

Relay Specification

Model:	B3GA4.5Z	
Material of the touch	Silver	
Rating (Resistance Load)	Rated switch capacity	30VDC 1A, 125VAC 0.3A
	Maximum switch power	62.5VA 30W
	Maximum switch voltage	250VAC, 220VDC
	Maximum switch currency	1A
Insulation	Between touches with same polarity	1000VAC 1minute
	Between touches with different polarity	1000VAC 1minute
	Between touch and winding	1000VAC 1minute
Surge voltage	Between touches with same polarity	1500VAC (10×160us)
Length of open time	3ms max	
Length of close time	3ms max	
Longevity	Mechanical	50×106 times (3Hz)
	Electrical	100×103 MIN 1A 30VDC(0.5Hz) 100×103 MIN 0.3A 125VDC(0.5Hz)
Temperature	-40℃ ~+85℃	

4 Operation

4.1 Boot up& Shutdown

The buzzer beeps once after system successfully booted up.

You can see the corresponding record status indicator light if system is recording after booted up.

The system can automatically backup video and resume previous working status after power outage.

4.1.1 Boot up

Turn the key to ACC, you can see power indicator light becomes on and DVR boots up (DVR boots up might take several seconds). After booted up, system is in multiple-window mode and schedule record status (Chapter 4.10.3) by default. The record indicator light becomes on too if the device is in the record period.

In the default setup, the device will automatically shut down after the ACC power is disconnected.

The ACC delay value ranges from 0 to 65535 (Unit: minute). System can delay shutting down for the specified time and then turn off (Main menu->Advanced->Auto maintenance) .

4.1.2 Schedule Boot up & Shutdown

System enables schedule record function if the boot up is within the specified period. You can see the corresponding record indicator light becomes on and system runs normally.

4.2 Startup Wizard

After system booted up, system pops up the startup wizard.

Click the Cancel button; you can go to the system login interface.

Click the Next Step button; you can login first and then go to the startup wizard interface. Here you can set the system basic information. See Figure 4-1.



Figure 4-1

4.3 Login

You can see login interface. See Figure 4-2.

System consists of three accounts. You can refer to chapter 4.11.4 Account for detailed operation information.

- **Username:** admin. **Password:** admin. (administrator, local and network)
- **Username:** 888888. **Password:** 888888. (administrator, local only)
- **Username:** default. **Password:** default(hidden user)

You can use USB2.0 mouse to input. Click  to switch between numeral, English character (small/capitalized) and denotation.

Note:

For security reason, please modify password after you first login.

Continuous three times login failure will result in system alarm and five times login failure will result in account lock.

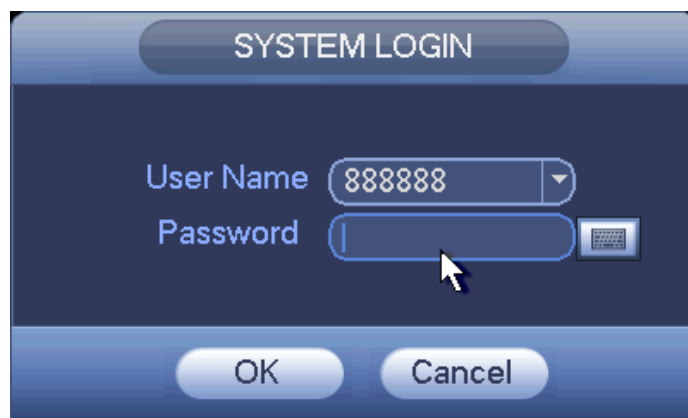



Figure 4-2

4.4 Preview

After you successfully logged in, you can go to preview interface directly. See Figure 4-3. You can overlay the corresponding date, time and channel name on each screen. You can refer to the following sheet for detailed information.

SN	Icon
1	Display plate number. For detailed setup information, please refer to chapter 4.10.1 General.
2	Display device working temperature.
3	Display current vehicle speed.
4	Display system time and date.
5	Network icon. It includes WIFI, 3G, GPRS, DSS platform.
6	Current longitude and latitude.
7	 : Video loss occurs.
8	 Current channel is recording now.

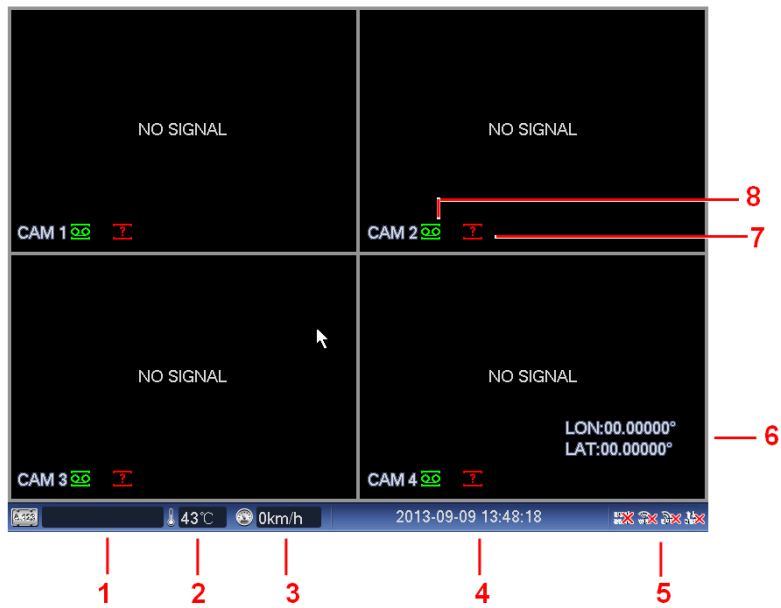

Figure 4-3

4.5 Right-Click Menu

On the preview interface, right click mouse, you can view menu interface shown as in Figure 4-4.

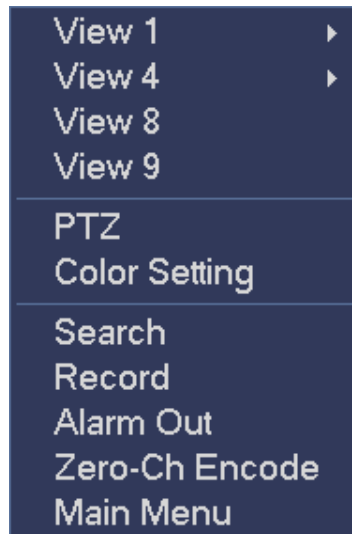

Figure 4-4

4.5.1 Window Switch

System supports 1/4/8/9-window. You can select from the dropdown list. See Figure 4-5.

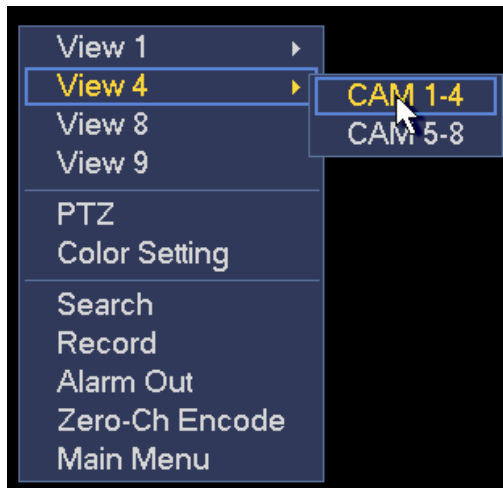

Figure 4-5

4.5.2 PTZ Control

Before you go to PTZ control interface, please go to chapter 4.10.8 to set PTZ parameter. See Figure 4-6.



Figure 4-6

4.5.3 Color

Here you can set hue, brightness, contrast, saturation, gain, white level, color mode and etc. See Figure 4-7.

Note

White level setup is for the 1st and the 5th channel only. The 1st to 4th channel share the 1st channel setup and the 5th to 8th channel share the 5th channel setup.

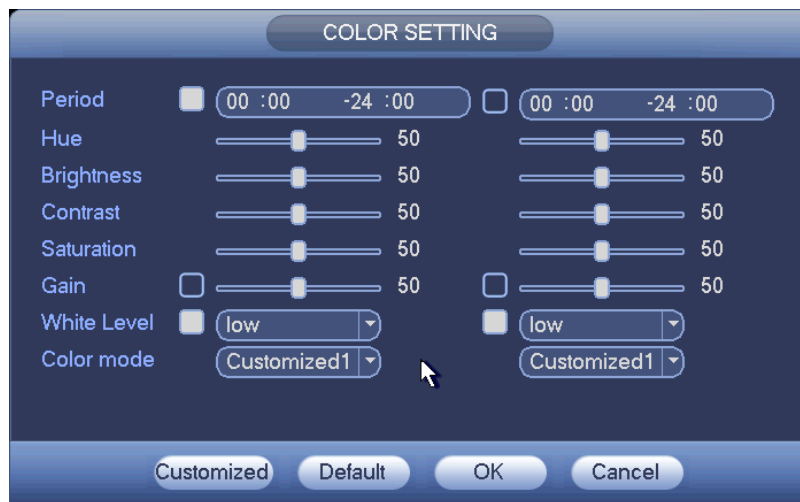

Figure 4-7

4.5.4 Search

Please refer to chapter 4.7.

4.5.5 Record Control

Please refer to chapter 4.11.3.

4.5.6 Alarm Output

Please refer to chapter 4.11.2.

4.5.7 Zero-channel encoding

Please refer to chapter 4.10.9.

4.6 Main Menu

After you logged in, the system main menu is shown as below. See Figure 4-8. There are total seven icons: search, Information, vehicle, setting, backup, advanced and shutdown. Move the cursor to highlight the icon, then double click mouse to enter the sub-menu.

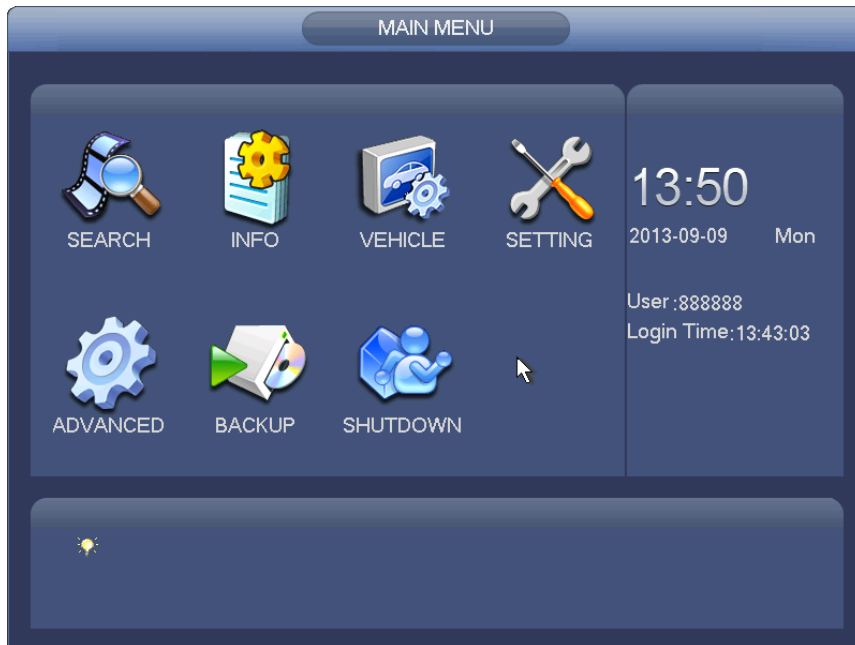

Figure 4-8

4.7 Search & Playback

Click search button in the main menu, search interface is shown as below. See Figure 4-9.

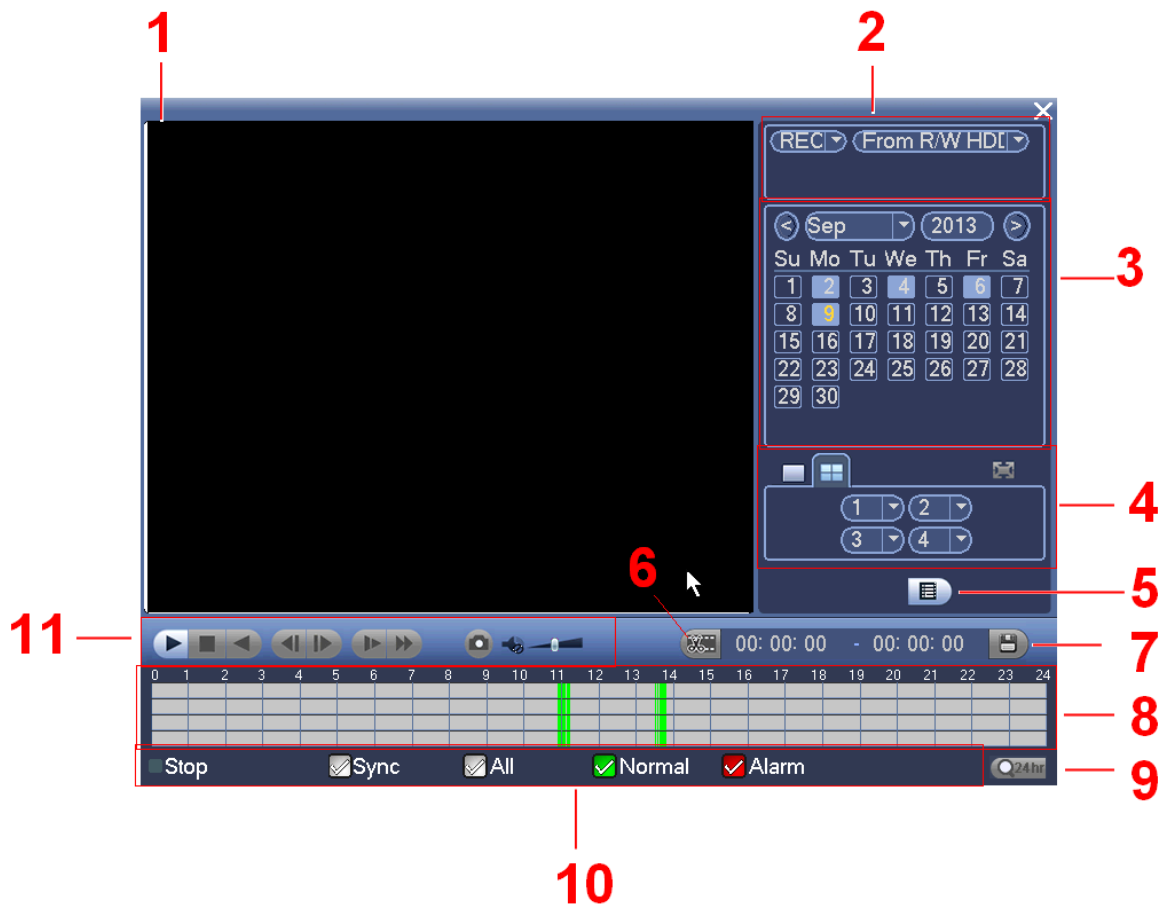

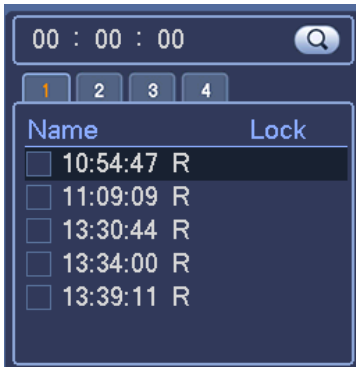



Figure 4-9

Please refer to the following sheet for more information.

SN	Name	Function
1	Display window	<ul style="list-style-type: none"> ● Here is to display the searched picture or file. ● Support 1/4-window playback.
2	Search type	<ul style="list-style-type: none"> ● Here you can select to search the picture or the recorded file. ● You can select to play from the read-write HDD, from I/O device. ● The interface is shown as below if you want to search a picture. You can set activation interval. See Figure 4-10.  <p style="text-align: center;">Figure 4-10</p>
3	Calendar	<ul style="list-style-type: none"> ● The blue highlighted date means there is picture or file. Otherwise, there is no picture or file. ● In any play mode, click the date you want to see, you can see the corresponding record file trace in the time bar.
4	Playback mode and channel selection pane.	<ul style="list-style-type: none"> ● Playback mode: 1/4. ◇ In 1-window playback mode: you can select 1-4(8) channels. ◇ In 4-window playback mode: you can select 4 channels according to your requirement. ● The time bar will change once you modify the playback mode or the channel option.
5	File list switch button	<ul style="list-style-type: none"> ● Double click it; you can view the picture/record file list of current day. ● The file list is to display the first channel of the record file. See Figure 4-11.  <p style="text-align: center;">Figure 4-11</p> <ul style="list-style-type: none"> ● The system can display max 128 files in one time. Use the ▲/▼ or the mouse

to view the file. Select one item, and then double click the mouse or click the ENTER button to playback.

- You can input the period in the following interface and click button  to begin accurate search. Comparing with the above Figure 4-11, you can see the first record file begin with the 11.09:09. See Figure 4-12.

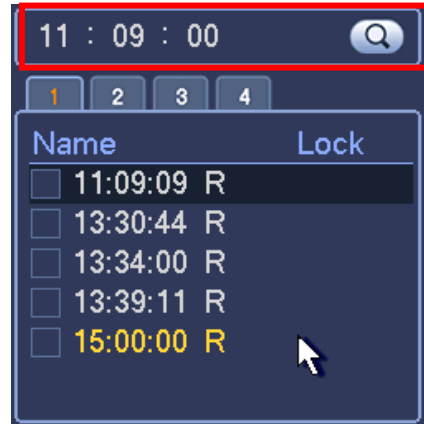

















Figure 4-12

- File type: R—regular record; A—external alarm record.
- Lock file. Click the file you want to lock and click the button  to lock. The file you locked will not be overwritten.
- Search locked file: Click the button  to view the locked file.
- Return: Click button , system goes back to the calendar and channel setup interface.

6	Clip	Please refer to chapter 5.9 for detailed information.
7	Save	
8	Time bar	Display current record type and its corresponding period.
9	Time bar unit	<ul style="list-style-type: none"> ● The option includes: 24H, 12H, 1H and 30M. The smaller the unit, the larger the zoom rate. You can accurately set the time in the time bar to playback the record. ● The time bar is beginning with 0 o'clock when you are setting the configuration. The time bar zooms in the period of the current playback time when you are playing the file.
10	Record type	There are three modes: Alarm/regular/all. In any play mode, the time bar will change once you change record type.

11	Playback control pane.		<p>Play/Pause</p> <p>There are three ways for you to begin playback.</p> <ul style="list-style-type: none"> ● The play button ● Double click the valid period of the time bar. ● Double click the item in the file list. <p>In slow play mode, click it to switch between play/pause.</p>
			Stop
			<p>Backward play</p> <p>In normal play mode, left click the button, the file begins backward play. Click it again to pause current play.</p> <p>In backward play mode, click  to restore normal play.</p>
			<p>In playback mode, click it to play the next or the previous section. You can click continuously when you are watching the files from the same channel.</p> <p>In normal play mode, when you pause current play, you can click  and  to begin frame by frame playback.</p> <p>In frame by frame playback mode, click  to restore normal playback.</p>
			<p>Slow play</p> <p>In playback mode, click it to realize various slow play modes such as slow play 1, slow play 2, and etc.</p>
			<p>Fast forward</p> <p>In playback mode, click to realize various fast play modes such as fast play 1, fast play 2 and etc.</p>
		Note: The actual play speed has relationship with the software version.	
			The volume of the playback
			<p>Click the snapshot button in the full-screen mode, the system can snapshot 1 picture per second.</p> <p>System supports custom snap picture saved path. Please connect the peripheral device first, click snap button on the full-screen mode, you can select or create path. Click Start button, the snapshot picture can be saved to the specified path.</p>
Other Functions			
13	Other channel synchronization switch to play when playback	When playing the file, click the number button, system can switch to the same period of the corresponding channel to play.	
14	Digital zoom	When the system is in full-screen playback mode, left click the mouse in the screen. Drag your mouse in the screen to select a section and then left click mouse to realize digital zoom. You can right click mouse to exit.	

Note:

All the operations here (such as playback speed, channel, time and progress) have relationship with hardware version. Some series DVRs do not support some functions or playback speeds.

4.8 Information

Here is for you to view system information. There are total eight items: HDD (hard disk information), BPS (data stream statistics), log, Version, online user, device, network test, network load. See Figure 4-13.



Figure 4-13

4.8.1 HDD Information

Here is to list hard disk type, total space, free space, and status. See Figure 4-14.

o means current HDD is normal.. - means there is no HDD.

If disk is damaged, system shows as "?". Please remove the broken hard disk before you add a new one.

Once there is a hard disk confliction, please check hard disk time and system time is the same or not. Please go to setting then general to modify system time. At last, reboot the system to solve this problem.

After system booted up, if there is any confliction, system goes to HDD information interface directly. Please note, system does not ask you to deal with it forcedly.



Figure 4-14

In Figure 4-14, click view record time button, HDD record time information interface is shown as in Figure 4-15.



Figure 4-15

Parameter	Function
SATA	1-2 here means system max supports 2 HDDs. When HDD is working properly, system is shown as O. . “_” means there is no HDD.
SN	You can view the HDD amount the device connected to; * means the second HDD is current working HDD.

Type	The corresponding HDD property.	
Total space	The HDD total capacity.	
Free space	The HDD free capacity.	
Status	HDD can work properly or not.	
Bad track	Display there is bad track or not.	
Page up	Click it to view previous page.	
Page down	Click it to view the next page.	
View recording time	Click it to view HDD record information (file start time and end time).	
View HDD type and capability	Click it to view HDD property, status and etc,	

4.8.2 BPS

Here is for you to view current video data stream (Kb/S) and occupied hard disk storage (MB/h). See Figure 4-16.



Figure 4-16

4.8.3 Log

Here is for you to view system log file. System lists the following information. See Figure 4-17. Log types include system operation, configuration operation, data management, alarm event, record operation, account management, log clear, file operation and etc.

- Start time/end time: Please select start time and end time, then click search button. You can view the log files in a list. System max displays 100 logs in one page. It can max save 1024 log files. Please use page up/down button on the interface or the front panel to view more.
- Backup: Please select a folder you want to save; you can click the backup button to save the log files. After the backup, you can see there is a folder named Log_time on the backup path. Double click the folder, you can see the log file
- Details: Click the Details button or double click the log item, you can view the detailed information. See Figure 4-18. Here you can use rolling bar to view information, or you can use Page up/Page down to view other log information.

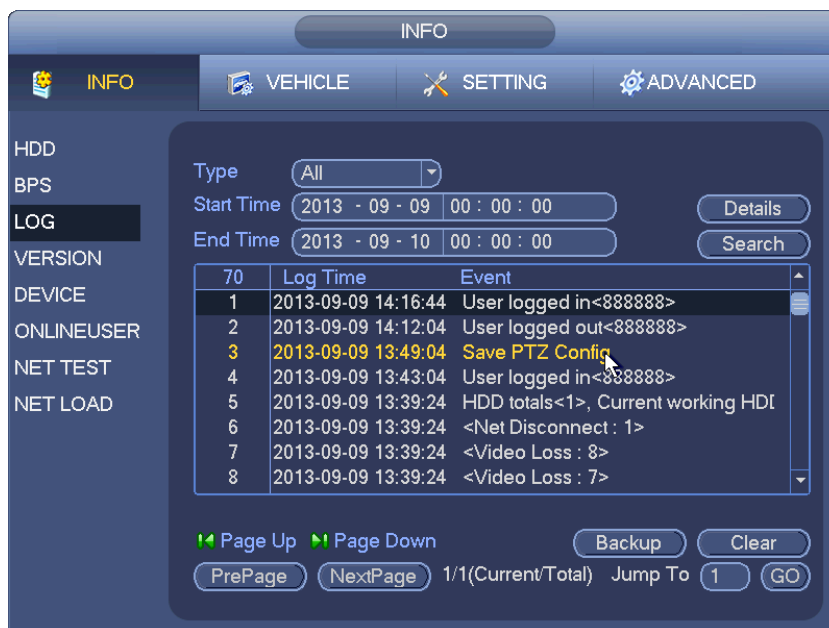

Figure 4-17

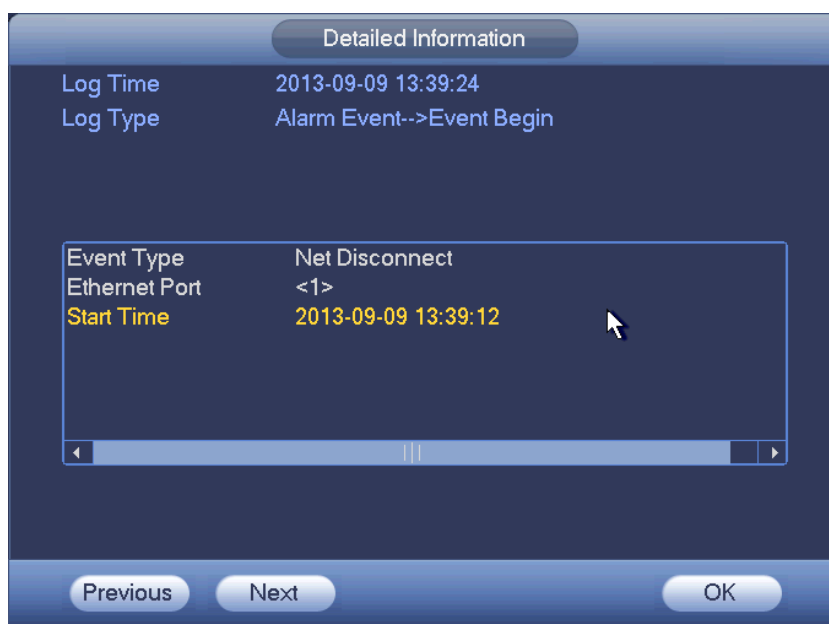

Figure 4-18

4.8.4 Version

Here is for you to view some version information. See Figure 4-19.

- System version:
- Build Date
- Web
- Serial number
- Model
- Upgrade
- Start: Please insert the USB device that have the update file to the device and then click the Start button to begin the update. See Figure 4-20.

Important

Please make sure the upgrade file name shall be update.bin.

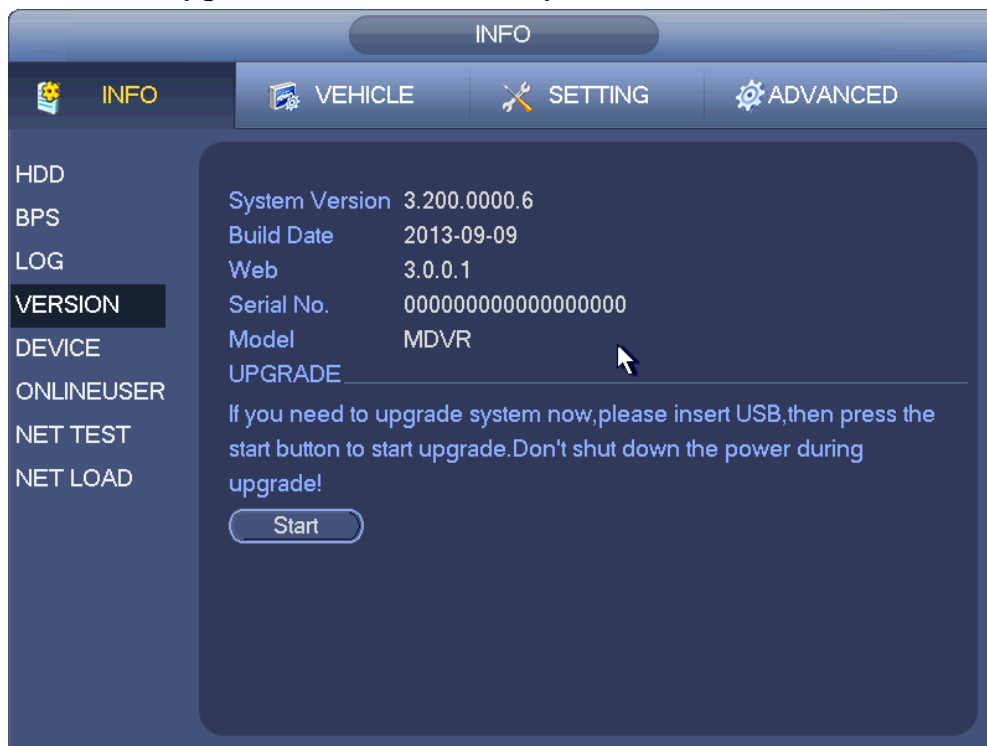

Figure 4-19



Figure 4-20

4.8.5 Device

Here you can view some device basic information. See Figure 4-21.



Figure 4-21

4.8.6 Online Users

Here is for you manage WEB online users connected to the local device. See Figure 4-22. You can disconnect one user or block one user if you have proper system right.



Figure 4-22

4.8.7 Network Test

Network test interface is shown as in Figure 4-23.

Destination IP: Please input valid IPV4 address and domain name.

Test: Click it to test the connection with the destination IP address. The test results can display average delay and packet loss rate and you can also view the network status as OK, bad, no connection and etc.

Network Sniffer backup: Please insert USB2.0 device and click the Refresh button, you can view the device on the following column. You can use the dropdown list to select peripheral device. Click Browse button to select the snap path. The steps here are same as preview backup operation.



Figure 4-23

4.8.8 Network Load

Network load is shown as in Figure 4-24. Here you can view the follow statistics of the device

network adapter. The green wave is send out speed and red wave is receive speed.

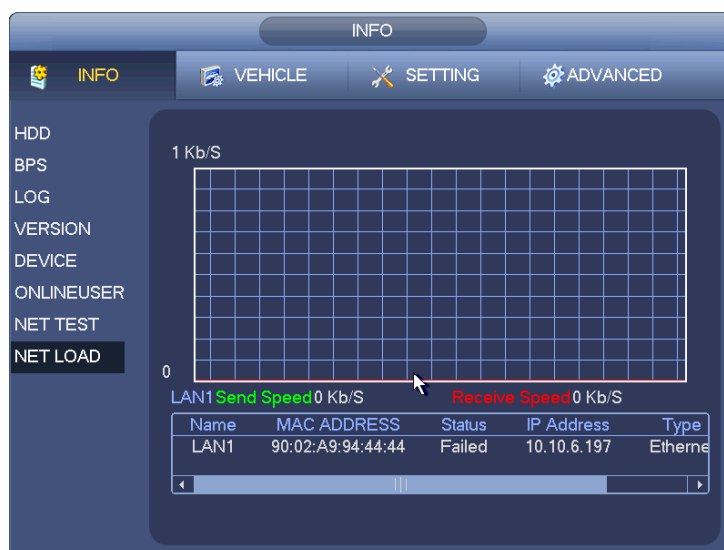

Figure 4-24

4.9 Vehicle

4.9.1 3G

3G setup interface is shown as below. See Figure 4-25.

Please follow the steps listed below to set.

- Boot up 3G module and then check the 3G Enable box to enable this function.
- Usually, click the Connect button, you can see the 3G module begins dialing. The 3G module can auto dial after device boots up the next time.
- Please set AUTH, dial number, user name, and password. Please contact the VPN administrator or your 3G service provider for detailed setup information.
- 3G network is to connect to a platform so that you can view vehicle real-time information such as real-time video, driver status, vehicle position and etc.
- The WIFI has the higher priority than the 3G network when these two signals are available at the same. In this situation, the device uses WIFI network by default and disconnect 3G network.
- If you find the 3G module can not dial, or it can not connect to the platform after dial. Please refer to the FAQ or contact your local retailer for help.

Please refer to the following contents for the parameter information.

- Pane 1: Display 3G signal intensity after you enabled 3G function.
- Pane 2: Display 3G module configuration information after you enabled 3G function.
- Pane 3: Display 3G module status information after you enabled 3G function.

It is to display current wireless network signal intensity such as EVDO, CDMA1x, WCDMA, WCDMA, EDGE and etc.

- 3G module: It is to display current wireless network adapter name.
- 3G Enable/Disable: Check the box here to enable 3G module.
- Network type: There are various network types for different 3G network modules. You can select according to your requirements.
- APN: It is the wireless connection server. It is to set you access the wireless network via which method.

- AUTH: It is the authentication mode. It supports PAP/CHAP.
- Dial number: Please input 3G network dialup number you got from your ISP.
- Connect/Disconnect; Click it to connect or disconnect 3G network.
- User name: It is the user name for you to login the 3G network.
- Password: It is the password for you to login the 3G network.
- Pulse interval: You can set dialup duration. Once you disable the extra stream, the connection time begins. For example, if you input 5 seconds here, then 3G network connection period is 5 seconds. The device automatically disconnect when time is up. If there is no extra stream, 3G network connection is valid all the time. **If the alive time is 0, then the 3G network connection is valid all the time.**
- Dial: Here you can enable or disable 3G network connection/disconnection manually.
- 3G wireless network: Here is to display wireless network status, SIM card status, dial status. If the 3G connection is OK, then you can see the device IP address the wireless network automatically allocates.

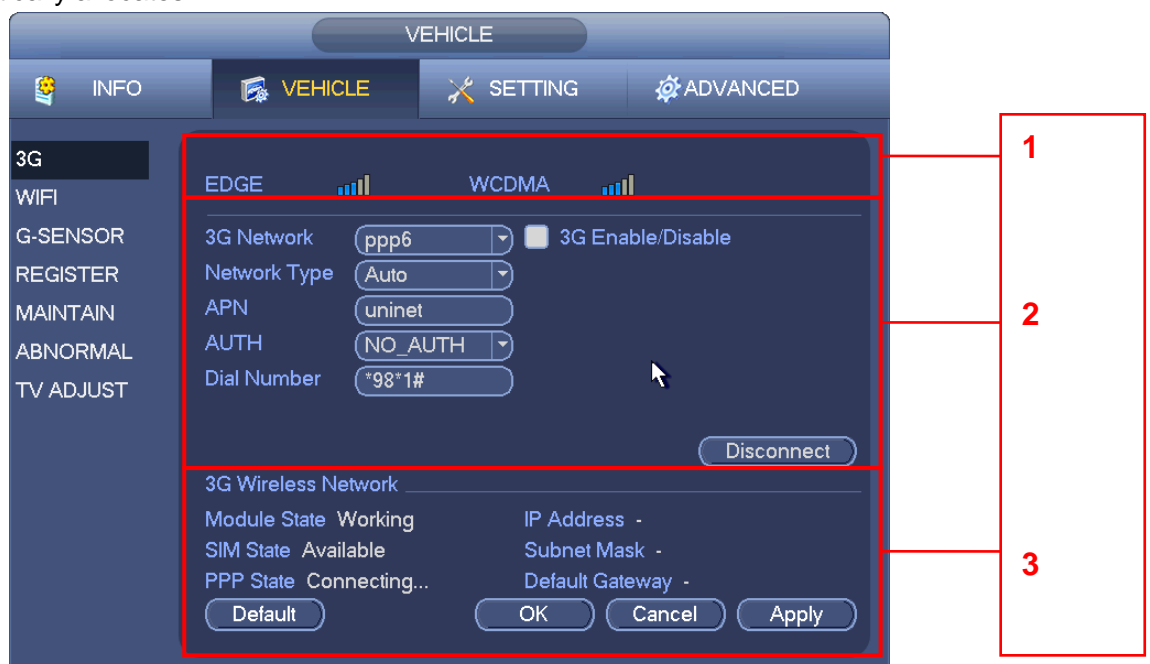

Figure 4-25

4.9.2 WIFI

The WIFI interface is shown as below. See Figure 4-26.

Please follow the steps listed below to set.

- Boot up a WIFI module and then check the Auto Connect WIFI box to enable WIFI function.
- In Figure 4-26, click Refresh button to view the entire WIFI signals available.
- Double click a WIFI signal on the list, you can see the WIFI connection dialogue box. See Figure 4-27.
- Select the corresponding verification type. Please contact your network administrator if you do not know how to select the type here. The WIFI connection shall set proper password. Usually we recommend the verification type as WPA2-PSK instead of WEP..
- Input WIFI connection password.
- Please select DHCP if your WIFI is to auto allocate IP address. Please set the corresponding IP/subnet mask/gateway if your WIFI needs a specified IP.

- g) Please note you must set WIFI priority when you set. The priority ranges from 1 to 5 and the 5 has the highest priority. When there are several WIFI signals available, system can try to connect one by one according to the priority setup.
- h) Please click Save button to save the setup and then click Connect button to connect manually.
- i) After you save WIFI hotspot setup, you can view it on the static setup interface. After device booted up, system can auto connect to the hotspot you set at the static setup interface once the Auto connect WIFI box is checked.
- j) Please disconnect WIFI connection before you modify WIFI network parameter. Do not modify WIFI setup when it is online.



Figure 4-26



Figure 4-27

After successfully connection, you can see the following interface. You can see it is connected

now. See Figure 4-28.



Figure 4-28

4.9.3 G-Sensor

The G-Sensor interface is shown as in Figure 4-29. Here you can set device orientation and sensitivity.



Figure 4-29

4.9.4 Register

This function allows the device to auto register to the proxy you specified. In this way, you can use the client-end to access the DVR and etc via the proxy. Here the proxy has a switch function. In the network service, device supports the server address of IPv4 or domain.

Please follow the steps listed below to use this function.

Please set proxy server address, port, and sub-device name at the device-end. Please enable the auto register function, the device can auto register to the proxy server.

1) The setup interface is shown as in Figure 4-30.

Important

Do not input network default port such as TCP port number.



Figure 4-30

2) The proxy server software developed from the SDK. Please open the software and input the global setup. Please make sure the auto connection port here is the same as the port you set in the previous step.

3) Now you can add device. Please do not input default port number such as the TCP port in the mapping port number. The device ID here shall be the same with the ID you input in Figure 4-30. Click Add button to complete the setup.

4) Now you can boot up the proxy server. When you see the network status is Y, it means your registration is OK. You can view the proxy server when the device is online.

Important

The server IP address can also be domain. But you need to register a domain name before you run proxy device server.

4.9.5 Auto Maintenance

Here you can set auto-reboot time and auto-delete old files, auto shutdown, and auto ACC delay (0-65535 minutes) setup. You can set to delete the files for the specified days. See Figure 4-31.

After all the setups please click save button, system goes back to the previous menu.

Note

- The auto boot up and ACC delay function is only valid when vehicle ACC signal connection is OK. The auto shut down has higher priority than ACC delay. If you enable these two functions at the same time, the ACC delay function is null.
- System default setup is to restart on each 2:00 Tuesday.



Figure 4-31

4.9.6 Abnormality

Abnormality interface is shown as in Figure 4-33.

- Event type: There are several options for you such as disk error, no disk, no space, high temperature, low battery, overspeed, low speed and etc. (multiple choices).
- Enable: Check the box here to enable this function.
- Alarm output: Please select alarm activation output port (multiple choices).
- Less than: You can set HDD threshold here so that system can alert you once the HDD space is lower than the threshold here.
- Latch: Here you can set corresponding delaying time. The value ranges from 1s-300s. System automatically delays specified seconds in turning off alarm and activated output after external alarm cancelled.
- Show message: system can pop up the message in the local screen to alert you when an alarm occurs.
- Alarm upload: System can upload the alarm signal to the network (including alarm centre) if you enabled current function.
- Send email: System can send out email to alert you when an alarm occurs.
- Restart system: If you highlight the button here, system will restart automatically if there is no HDD.
- Buzzer: Highlight the icon to enable this function. The buzzer beeps when an alarm occurs.

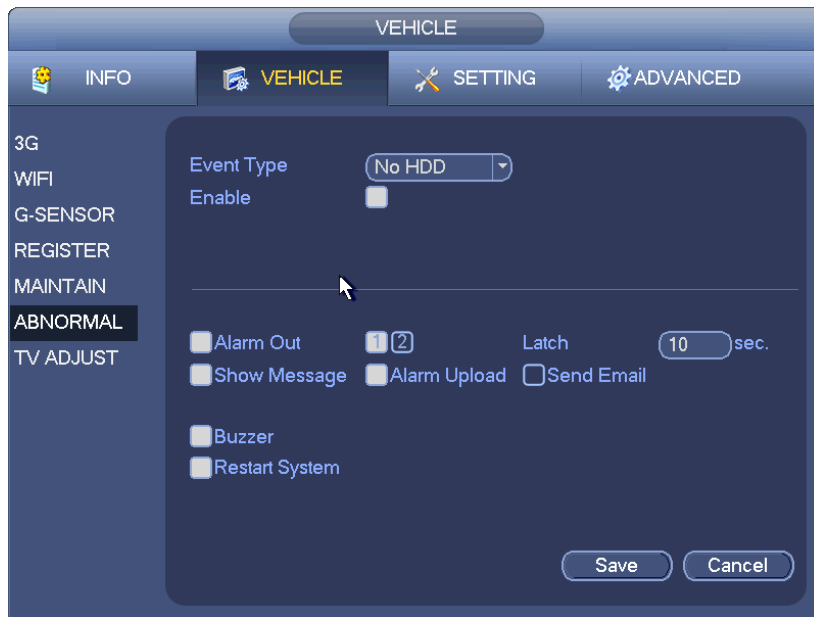

Figure 4-32

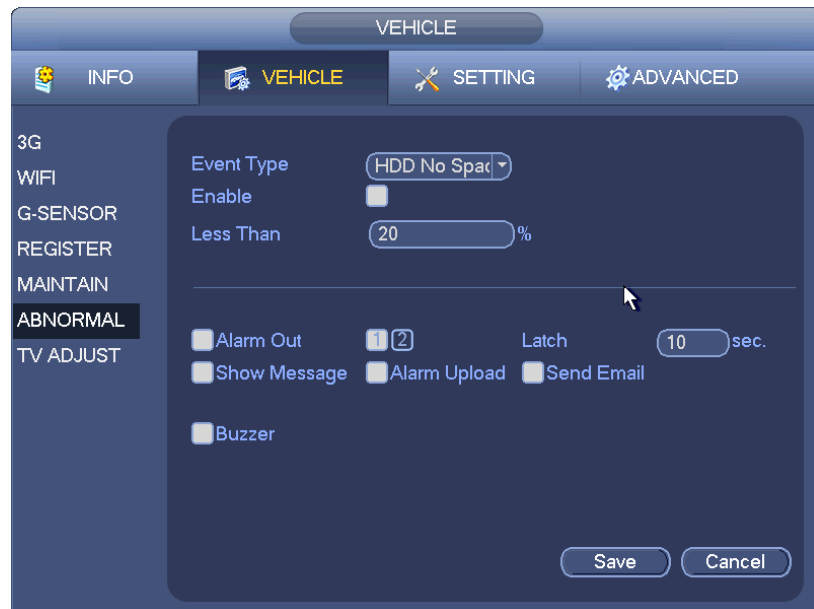

Figure 4-33

4.9.7 TV Adjust

Here is for you to adjust TV output setup. See Figure 4-34.

Please drag slide bar to adjust each item.

After all the setups please click OK button, system goes back to the previous menu.



Figure 4-34

4.10 Setting

In main menu, highlight setting icon and double click mouse. System setting interface is shown as below. See Figure 4-35.



Figure 4-35

Important

Please note you need to have the proper right to implement the following operation.

4.10.1 General

General setting includes the following items. See Figure 4-36.

- System time: Here is for you to set system time

- Date format: There are three types: YYYY-MM-DD: MM-DD-YYYY or DD-MM-YYYY.
- Date separator: There are three denotations to separate date: dot, beeline and solidus.
- DST: Here you can set DST time and date. Please enable DST function and then click set button. You can see an interface is shown as in Figure 4-37. Here you can set start time and end time by setting corresponding week setup. In Figure 4-37, enable date button, you can see an interface is shown as in Figure 4-38. Here you can set start time and end time by setting corresponding date setup.
- Time format: There are two types: 24-hour mode or 12-hour mode.
- Language: System supports various languages: Chinese (simplified), Chinese (Traditional), English, Italian, Japanese, French, Spanish (All languages listed here are optional. Slight difference maybe found in various series.)
- HDD full: Here is for you to select working mode when hard disk is full. There are two options: stop recording or rewrite. If current working HDD is overwritten or the current HDD is full while the next HDD is no empty, then system stops recording, If the current HDD is full and then next HDD is not empty, then system overwrites the previous files.
- Pack duration: Here is for you to specify record duration. The value ranges from 1 to 120 minutes. Default value is 60 minutes.
- Device No: When you are using one remote control (not included in the accessory bag) to control several DVRs, you can give a name to each DVR for your management.
- Video standard: There are two formats: NTSC and PAL.
- Realtime play: It is to set playback time you can view in the preview interface. The value ranges from 5 to 60 minutes.
- Device ID: Please input a corresponding device name here.
- License No: Here you can set vehicle plate number.
- Auto logout: Here is for you to set auto logout interval once login user remains inactive for a specified time. Value ranges from 0 to 60 minutes.
- Preview bar: Check the box here, system displays the navigation bar on the interface when you boot up device the next time. Otherwise, it goes to the system login interface directly. You can check the box to select overlay position.
- Startup wizard: Once you check the box here, system will go to the startup wizard directly when the system restarts the next time. Otherwise, it will go to the login interface.

Note:

Since system time is very important, do not modify time casually unless there is a must!

Before your time modification, please stop record operation first!

After completing all the setups please click save button, system goes back to the previous menu.



Figure 4-36



Figure 4-37



Figure 4-38

4.10.2 Encode

Encode setting includes the following items. See Figure 4-39.

Please note some series do not support extra stream.

- Channel: Select the channel you want.
- Type: Please select from the dropdown list. There are two options: regular/alarm. You can set the various encode parameters for different record types.
- Compression: System supports H.264, MPEG4, MJPEG and etc.

- Resolution: System supports various resolutions, you can select from the dropdown list. The main stream supports 960H/D1/HD1/2CIF/CIF/QCIF and the extra stream supports CIF/QCIF. Please note the option may vary due to different series.
- Frame rate: It ranges from 1f/s to 25f/s in NTSC mode and 1f/s to 30f/s in PAL mode.
- Bit rate type: System supports two types: CBR and VBR. In VBR mode, you can set video quality.
- Quality: There are six levels ranging from 1 to 6. The sixth level has the highest image quality.
- Video/audio: You can enable or disable the video/audio. The main stream is enabled by default. The record includes audio and video if you highlight audio button here. For extra stream, you need to check video first and then select audio.
- Audio format: Here you can set device audio format: G711a, PCM, G711μ.
- Overlay: Click overlay button, you can see an interface is shown in Figure 4-42. Please note the following overlay titles can not be in the same position. **Please note only the unit of GPS module supports GPS overlay function.**
 - ✧ Cover area (Privacy mask): Here is for you to set privacy mask section. You can drag you mouse to set proper section size. In one channel video, system max supports 4 zones in one channel.
 - ✧ Preview/monitor: privacy mask has two types. Preview and Monitor. Preview means the privacy mask zone can not be viewed by user when system is in preview status. Monitor means the privacy mask zone can not be view by the user when system is in monitor status.
 - ✧ Time display: You can select system displays time or not when you playback. Please click set button and then drag the title to the corresponding position in the screen.
 - ✧ Channel display: You can select system displays channel number or not when you playback. Please click set button and then drag the title to the corresponding position in the screen.
 - ✧ License No. : You can select system displays car number or not when you playback.
 - ✧ GPS display: You can select system displays latitude and longitude or not when you playback.
- Snapshot: Click snapshot button, you can set snapshot mode, picture size, quality and frequency. See Figure 4-40.
 - ✧ Snapshot mode: There are two modes: Timing (Schedule) and activation. If you set timing mode, you need to set snapshot frequency. If you set activation snapshot, you need to go to Detect interface (Main menu->Setting-Detect) to set snapshot activation operation.
 - ✧ Image size: Here you can set snapshot picture size.
 - ✧ Image quality: Here you can set snapshot quality. The value ranges from 1 to 6.
 - ✧ Interval: It is for you to set timing (schedule) snapshot interval. The value ranges from 1-7 picture(s) per second.
 - ✧ Schedule: Click it; you can see an interface shown as in Figure 4-41. Here you can set snapshot period.
- Copy: After you complete the setup, you can click Copy button to copy current setup to other channel(s). You can see an interface is shown as in Figure 4-43. You can see current channel number is grey. Please check the number to select the channel or you can check the box ALL. Please click the OK button in Figure 4-43 and Figure 4-39 respectively to complete the setup.

Please highlight icon  to select the corresponding function.



Figure 4-39



Figure 4-40

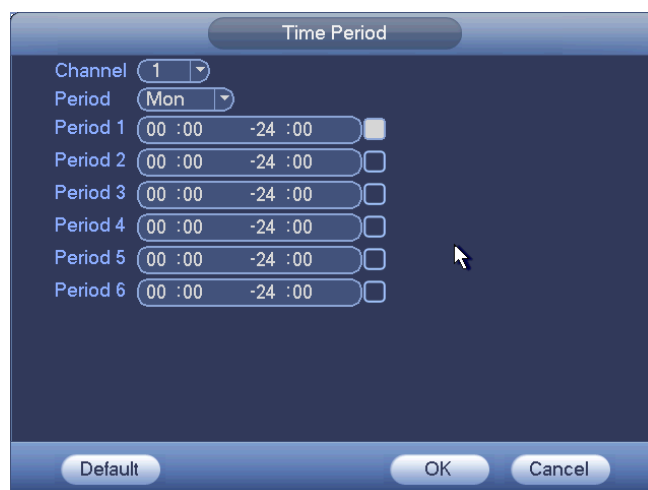

Figure 4-41



Figure 4-42

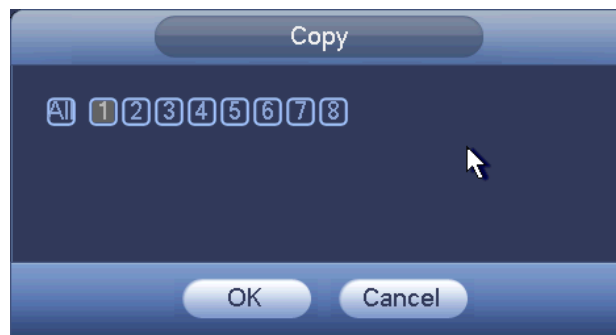



Figure 4-43

4.10.3 Schedule

In the main menu, from setting to schedule, you can go to schedule menu. See Figure 4-44.

- Channel: Please select the channel number first. You can select “all” if you want to set for the whole channels.
- Week day: There are eight options: ranges from Saturday to Sunday and all.
- Pre-record: System can pre-record the video before the event occurs into the file. The value ranges from 1 to 30 seconds depending on the bit stream.
- Redundancy: System supports redundancy backup function. It allows you backup recorded file in two disks. You can highlight Redundancy button to activate this function. Please note, before enable this function, please set at least one HDD as redundant. (Main menu->Advanced->HDD Management). **Please note this function is null if there is only one HDD.**
- Snapshot: You can enable this function to snapshot image when an alarm occurs.
- Record types: There are two types: regular, Alarm.
- Holiday: Highlight the button here, the holiday settings in General interface (Chapter 4.10.1) becomes activated.

Please highlight icon  to select the corresponding function. After completing all the setups please click save button, system goes back to the previous menu.

At the bottom of the menu, there are color bars for your reference. Green color stands for regular recording and red color stands for alarm recording.



Figure 4-44

4.10.4 RS232

RS232 interface is shown as below. There are five items. See Figure 4-45.

- Function: There are various devices for you to select.
 - ✧ Console is for you to use the COM or mini-end software to upgrade or debug the program.
 - ✧ The control keyboard is for you to control the device via the special keyboard.
 - ✧ Transparent COM (adapter) is to connect to the PC to transfer data directly.
 - ✧ Network keyboard is for you to use the special keyboard to control the device.
 - ✧ PTZ matrix is to connect to the peripheral matrix control.
- Baud rate: You can select proper baud rate.
- Data bit: You can select proper data bit. The value ranges from 5 to 8.
- Stop bit: There are two values: 1/2.
- Parity: there are five choices: none/odd/even/space/mark.

After completing all the setups please click save button, system goes back to the previous menu.



Figure 4-45

4.10.5 Network

Here is for you to input network information. See Figure 4-46.

- IP Version: There are two options: IPv4 and IPv6. Right now, system supports these two IP address format and you can access via them.
- MAC address: The host in the LAN can get a unique MAC address. It is for you to access in the LAN. It is read-only.
- IP address: Here you can use up/down button (▲▼) or input the corresponding number to input IP address. Then you can set the corresponding subnet mask the default gateway.
- Subnet prefix: The input value ranges from 0 to 128. It is to mark a specified network MAC address. Usually it includes an organization of multiple-level.
- Default gateway: Here you can input the default gateway. **Please note system needs to check the validity of all IPv6 addresses. The IP address and the default gateway shall be in the same IP section. That is to say, the specified length of the subnet prefix shall have the same string.**
- DHCP: It is to auto search IP. When enable DHCP function, you can not modify IP/Subnet mask /Gateway. These values are from DHCP function. If you have not enabled DHCP function, IP/Subnet mask/Gateway display as zero. You need to disable DHCP function to view current IP information. Besides, when PPPoE is operating, you can not modify IP/Subnet mask /Gateway.
- TCP port: Default value is 37777. You can change if necessary.
- UDP port: Default value is 37778. You can change if necessary.
- HTTP port: Default value is 80.
- RTSP port: Default value is 554.

Important: System needs to reboot after you changed and saved any setup of the above four ports. Please make sure the port values here do not conflict.

- Max connection: system support maximal 20 users. 0 means there is no connection limit.
- Preferred DNS server: DNS server IP address.
- Alternate DNS server: DNS server alternate address.

- Transfer mode: Here you can select the priority between fluency/video qualities.
- LAN download: System can process the downloaded data first if you enable this function. The download speed is 1.5X or 2.0X of the normal speed.

Important

For the IP address of IPv6 version, default gateway, preferred DNS and alternate DNS, the input value shall be 128-digit. It shall not be left in blank.

After completing all the setups please click save button, system goes back to the previous menu.



Figure 4-46

4.10.5.1 Network Setting

Network setting interface is shown as in Figure 4-47. Please draw a circle to enable corresponding function and then double click current item to go to setup interface.



Figure 4-47

4.10.5.2 NTP Setup

You need to install SNTP server (Such as Absolute Time Server) in your PC first. In Windows XP OS, you can use command “net start w32time” to boot up NTP service.

NTP setup interface is shown as in Figure 4-48.

- Host IP: Input your PC address.
- Port: This series DVR supports TCP transmission only. Port default value is 123.
- Update interval: minimum value is 1. Max value is 65535. (Unit: minute)

- Time zone: select your corresponding time zone here.
- Update period: You can input interval here.
- Manual update: It allows you to synchronize the time with the server manually.

Here is a sheet for your time zone setup.

City /Region Name	Time Zone
London	GMT+0
Berlin	GMT+1
Cairo	GMT+2
Moscow	GMT+3
New Deli	GMT+5
Bangkok	GMT+7
Beijing (Hong Kong)	GMT+8
Tokyo	GMT+9
Sydney	GMT+10
Hawaii	GMT-10
Alaska	GMT-9
Pacific Time(P.T)	GMT-8
American Mountain Time(M.T)	GMT-7
American Central Time(C.T)	GMT-6
American Eastern Time(E.T)	GMT-5
Atlantic Time	GMT-4
Brazil	GMT-3
Middle Atlantic Time	GMT-2



Figure 4-48

4.10.5.3 DDNS

DDNS setup interface is shown as in Figure 4-49.

You need a PC of fixed IP in the internet and there is the DDNS software running in this PC. In other words, this PC is a DNS (domain name server).

In network DDNS, please select DDNS type and highlight enable item. Then please input your PPPoE name you get from you IPS and server IP (PC with DDNS) . Click save button and then reboot system.

Click save button, system prompts for rebooting to get all setup activated.

After rebooting, open IE and input the domain name.
Now you can open DDNSServer web search page.

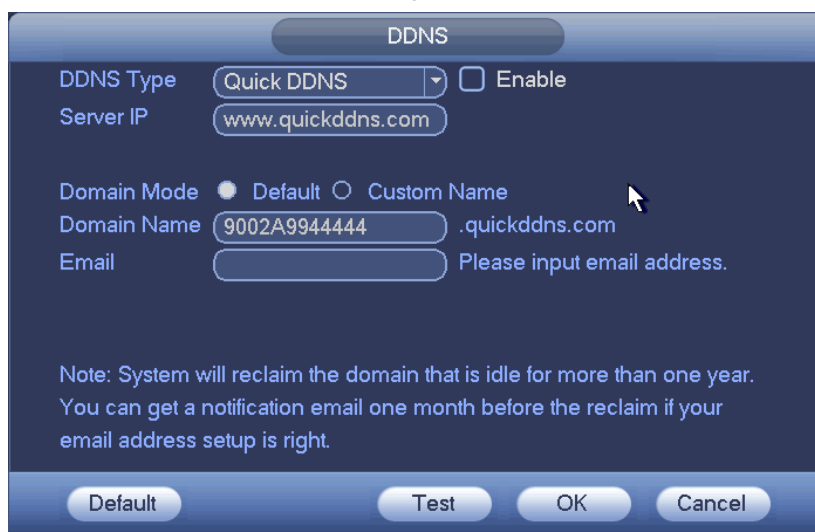

Figure 4-49

Please note NNDS type includes: CN99 DDNS, NO-IP DDNS, Quick DDNS, and DynDNS DDNS. All the DDNS can be valid at the same time, you can select as you requirement. Quick DDNS function shall work with special DDNS server and special Professional Surveillance Software (PSS).

Quick DDNS and Client-end Introduction

1) Background Introduction

Device IP is not fixed if you use ADSL to login the network. The DDNS function allows you to access the DVR via the registered domain name. Besides the general DDNS, the quick DDNS works with the device from the manufacturer so that it can add the extension function.

2) Function Introduction

The quick DDNS client has the same function as other DDNS client end. It realizes the bonding of the domain name and the IP address. Right now, current DDNS server is for our own devices only. You need to refresh the bonding relationship of the domain and the IP regularly. There is no user name, password or the ID registration on the server. At the same time, each device has a default domain name (Generated by MAC address) for your option. You can also use customized valid domain name (has not registered.).

3) Operation

Before you use our quick DDNS, you need to enable this service and set proper server address, port value and domain name.

- Server address: www.quickddns.com
- Port number: 80
- Domain name: There are two modes: Default domain name and customized domain name. Except default domain name registration, you can also use customized domain name (You can input your self-defined domain name.). After successful registration, you can use domain name to login installed of the device IP.
- User name: It is optional. You can input your commonly used email address.

Important

- Do not register frequently. The interval between two registrations shall be more than 60 seconds. Too many registration requests may result in server attack.
- System may take back the domain name that is idle for one year. You can get a notification email before the cancel operation if your email address setup is OK.

4.10.5.4 Email

The email interface is shown as below. See Figure 4-50.

- SMTP server: Please input your email SMTP server IP here.
- Port: Please input corresponding port value here.
- User name: Please input the user name to login the sender email box.
- Password: Please input the corresponding password here.
- Sender: Please input sender email box here.
- Title: Please input email subject here. System support English character and Arabic number. Max 32-digit.
- Receiver: Please input receiver email address here. System max supports 3 email boxes.
- SSL enable: System supports SSL encryption box.
- Interval: The send interval ranges from 0 to 3600 seconds. 0 means there is no interval.
- Health email enable: Please check the box here to enable this function. This function allows the system to send out the test email to check the connection is OK or not.
- Interval: Please check the above box to enable this function and then set the corresponding interval. System can send out the email regularly as you set here. Click the Test button, you can see the corresponding dialogue box to see the email connection is OK or not. See Figure 4-51.

Please note system will not send out the email immediately when the alarm occurs. When the alarm or the abnormality event activates the email, system sends out the email according to the interval you specified here. This function is very useful when there are too many emails activated by the abnormality events, which may result in heavy load for the email server.

The screenshot shows a configuration window titled "EMAIL". It contains the following fields and controls:

- SMTP Server: MailServer
- Port: 25
- User Name: (empty)
- Password: (empty)
- Receiver: (empty)
- Sender: (empty)
- Subject: DVR ALERT
- Event Interval: 120 sec.
- Health Enable:
- Interval: 60 min.

At the bottom of the window are four buttons: Default, OK, Cancel, and Test.

Figure 4-50

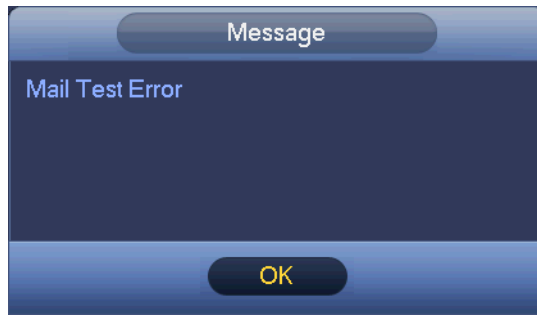

Figure 4-51

4.10.5.5 FTP

You need to download or buy FTP service tool (such as Ser-U FTP SERVER) to establish FTP service.

Please install Ser-U FTP SERVER first. From “start” -> “program” -> Serv-U FTP Server -> Serv-U Administrator. Now you can set user password and FTP folder. Please note you need to grant write right to FTP upload user. See Figure 4-52.

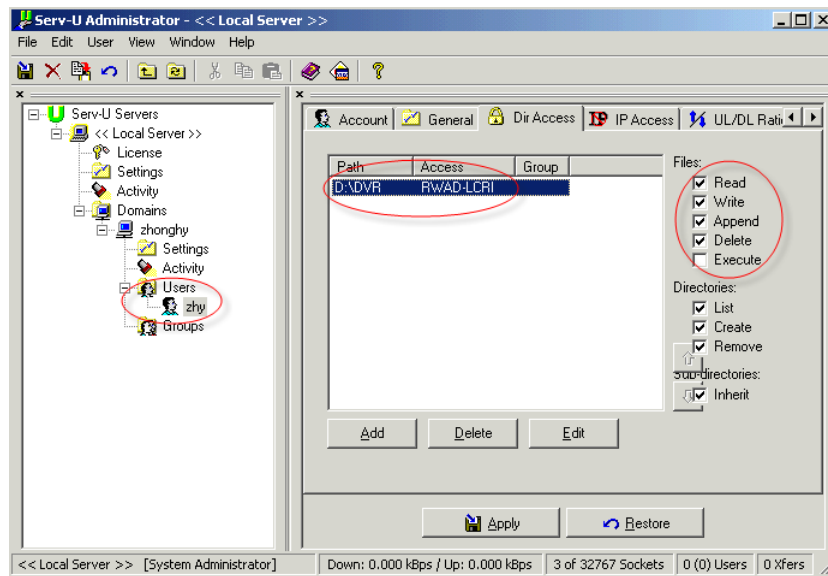

Figure 4-52

You can use a PC or FTP login tool to test setup is right or not.

For example, you can login user ZHY to [FTP://10.10.7.7](ftp://10.10.7.7) and then test it can modify or delete folder or not. See Figure 4-53.

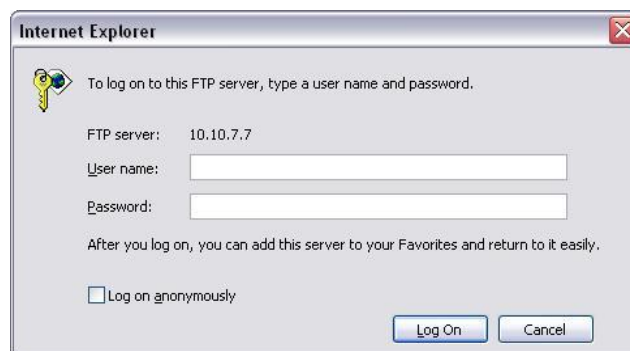



Figure 4-53

System also supports upload multiple DVRs to one FTP server. You can create multiple folders under this FTP.

In Figure 4-46, select FTP and then double click mouse. You can see the following interface. See Figure 4-54.

Please highlight the icon  in front of Enable to activate FTP function.

Here you can input FTP server address, port and remote directory. When remote directory is null, system automatically create folders according to the IP, time and channel.

User name and password is the account information for you to login the FTP.

File length is upload file length. When setup is larger than the actual file length, system will upload the whole file. When setup here is smaller than the actual file length, system only uploads the set length and auto ignore the left section. When interval value is 0, system uploads all corresponding files.

After completed channel and weekday setup, you can set two periods for one each channel.

Click the Test button, you can see the corresponding dialogue box to see the FTP connection is OK or not. See Figure 4-55.



Figure 4-54

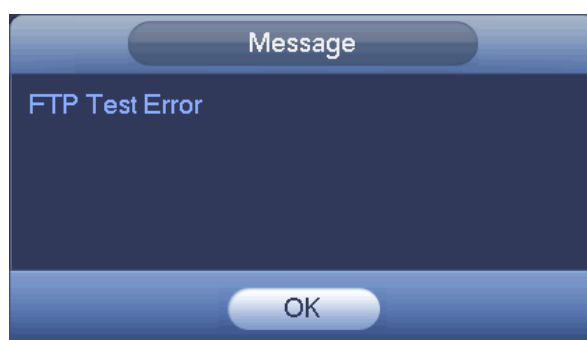

Figure 4-55

4.10.5.6 Alarm center

Interface is pre-reserved for the users to develop this function. See Figure 4-56.

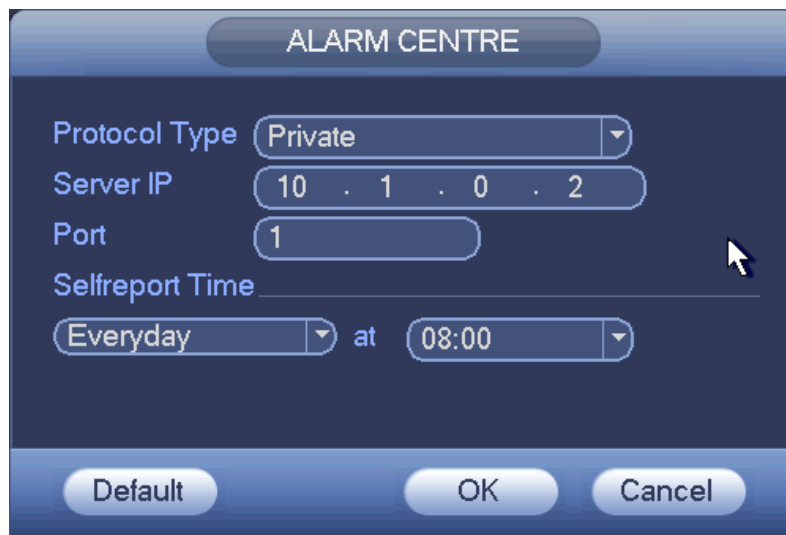

Figure 4-56

4.10.6 Alarm

You can follow the steps listed below to set.

- a) You can connect the external alarm port from the rear panel of the device. Usually the vehicle left-turn, right-turn, brake and door signal information and etc can be input to the device via the alarm input device.
- b) In the main menu, from Setting to Alarm, you can see alarm setup interface. See Figure 4-57.
- c) This series product support 6-channel level alarm information. You can set its actual alarm name such as left-turn, right-turn on the Alarm Name item. Check the Overlay button, you can overlay corresponding alarm information on the record file.
- d) If the alarm signal is 12V/24V voltage, the trigger type shall be high valid. If the alarm signal is ground signal, the trigger type shall be low valid.
- e) The normal open means the alarm signal is usually disconnect, system can generate an alarm when the alarm signal closed. The normal close means the alarm signal is usually connect, system can generate an alarm when the alarm signal disconnected.
- f) You need to set for each alarm channel on the Alarm in item if the device has connected several alarm channels.
 - Alarm in: Here is for you to select channel number.
 - Event type: There are two types. Local input/network input alarm.
 - ✧ Local input alarm: The alarm signal system detects from the alarm input port.
 - ✧ Network input alarm: It is the alarm signal from the network.
 - Enable: Please you need to highlight this button to enable current function.
 - Type: Normal open or normal close.
 - Trigger: Here is for you to set activation mode. There are two options: High/low.
 - Alarm name: You can input customized name here.
 - Overlay: Please highlight the box here to enable this function. It can overlay alarm information on the video screen when an alarm occurred.
 - PTZ activation: When an alarm occurred, system can activate the PTZ operation such as preset x.
 - Anti-dither: Here you can set anti-dither time. The value ranges from 5 to 600s. The anti-dither time refers to the alarm signal lasts time. It can be seem as the alarm signal

activation stays such as the buzzer, tour, PTZ activation, snapshot, channel record. The stay time here does not include the latch time. During the alarm process, the alarm signal can begin an anti-dither time if system detects the local alarm again. The screen prompt, alarm upload, email and etc will not be activated. For example, if you set the anti-dither time as 10 second, you can see the each activation may last 10s if the local alarm is activated. During the process, if system detects another local alarm signal at the fifth second, the buzzer, tour, PTZ activation, snapshot, record channel will begin another 10s while the screen prompt, alarm upload, email will not be activated again. After 10s, if system detects another alarm signal, it can generate an alarm since the anti-dither time is out.

- Alarm output: The number here is the device alarm output port. You can select the corresponding ports(s) so that system can activate the corresponding alarm device(s) when an alarm occurred.
- Latch: When the anti-dither time ended, the channel alarm you select in the alarm output may last the specified period. The value ranges from 1 to 300 seconds. This function is not for other alarm activation operations. The latch is still valid even you disable the alarm event function directly.
- Show message: System can pop up a message to alarm you in the local host screen if you enabled this function.
- Alarm upload: System can upload the alarm signal to the network (including alarm centre and the WEB) if you enabled current function. System only uploads the alarm channel status. You can go to the WEB and then go to the Alarm interface to set alarm event and alarm operation. Please go to the Network interface to set alarm centre information.
- Send email: System can send out the alarm signal via the email to alert you when alarm occurs. Once you enable the snap function, system can also send out an image as the attachment. Please go to the Main Menu->Setting ->Network->Email interface to set.
- Record channel: you can select proper channel to record alarm video (Multiple choices).
 - ◇ You need to set alarm record mode as Schedule in Record interface (Main Menu->Advanced->Record). Please note the manual record has the highest priority. System record all the time no matter there is an alarm or not if you select Manual mode.
 - ◇ Now you can go to the Schedule interface (Main Menu->Setting->Schedule) to set the record type, corresponding channel number, week and date. You can select the record type: Regular/Alarm.
 - ◇ Now you can go to the Encode interface to select the alarm record and set the encode parameter (Main Menu->Setting->Encode).
 - ◇ Finally, you can set the alarm input as the local alarm and then select the record channel. The select channel begins alarm record when an alarm occurred. Please note system begins the alarm record instead of the MD record if the local alarm and MD event occurred at the same time.
- Snapshot: You can enable this function to snapshot image when an alarm occurs.
- Buzzer: Highlight the icon to enable this function. The buzzer beeps when an alarm occurs.

Please highlight icon  to select the corresponding function. After setting all the setups please click save button, system goes back to the previous menu.



Figure 4-57

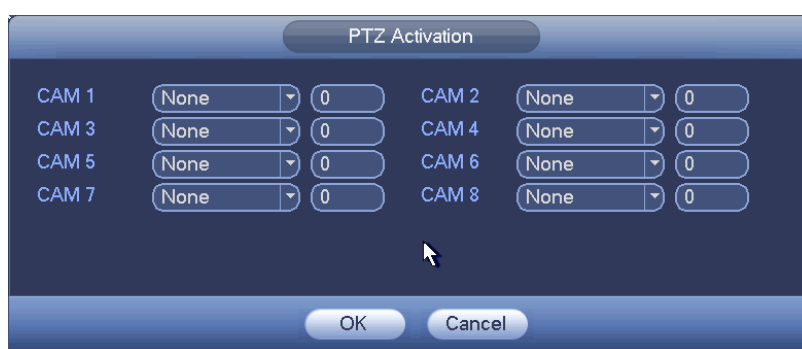

Figure 4-58

4.10.7 Detect

Go to Detect Menu

In the main menu, from Setting to Detect, you can see an interface shown as in Figure 4-59. There are two detection types: video loss/tampering.

- You can see video loss icon if current channel has enabled video loss alarm.

4.10.7.1 Video Loss

You can follow the steps listed below to set video loss alarm.

- From Main menu->Setting->Detect to set video loss item and enable this function.
- Select video loss from the dropdown list and select video loss channel.

Video loss is shown as below. See Figure 4-59.

- Event type: From the dropdown list you can select video loss type.
- Channel: Select a channel from the dropdown list to set video loss function.
- Enable: Check the box here to enable video loss function.
- Alarm output: when an alarm occurs, system enables peripheral alarm devices.
- Latch: when video loss is complete, system auto delays detecting for a specified time. The value ranges from 1-300(Unit: second)
- Show message: System can pop up a message to alarm you in the local host screen if you enabled this function.
- Alarm upload: System can upload the alarm signal to the network (including alarm centre) if you enabled current function.

- Send email: System can send out email to alert you when an alarm occurs.
- Record channel: Select the channel to activate recording function once an alarm occurred. Please make sure you have set MD record in encode interface(Main Menu->Setting->Schedule) and schedule record in manual record interface(Main Menu->Advanced->Manual Record)
- PTZ activation: Here you can set PTZ movement when an alarm occurs. System can go to a preset, when there is an alarm. Click “select” button, you can see an interface is shown as in Figure 4-60.
- Record Delay: System can delay the record for specified time after alarm ended. The value ranges from 10s to 300s.
- Snapshot: You can enable this function to snapshot image when video loss alarm occurs.
- Buzzer: Highlight the icon to enable this function. The buzzer beeps when an alarm occurs.

Please highlight icon  to select the corresponding function. After all the setups please click save button, system goes back to the previous menu.

Tips:

You can enable preset/tour/pattern activation operation when video loss occurs.



Figure 4-59



Figure 4-60

4.10.7.2 Tampering

When someone viciously masks the lens, or the output video is in one-color due to the environments light change, the system can alert you to guarantee video continuity. Tampering interface is shown as in Figure 4-61. You can enable alarm output channel and then enable show message function. You can refer to chapter 4.10.7.1 Video Loss for detailed information.

Note:

In Detect interface, copy/paste function is only valid for the same type, which means you can not copy a channel setup in video loss mode to tampering mode.

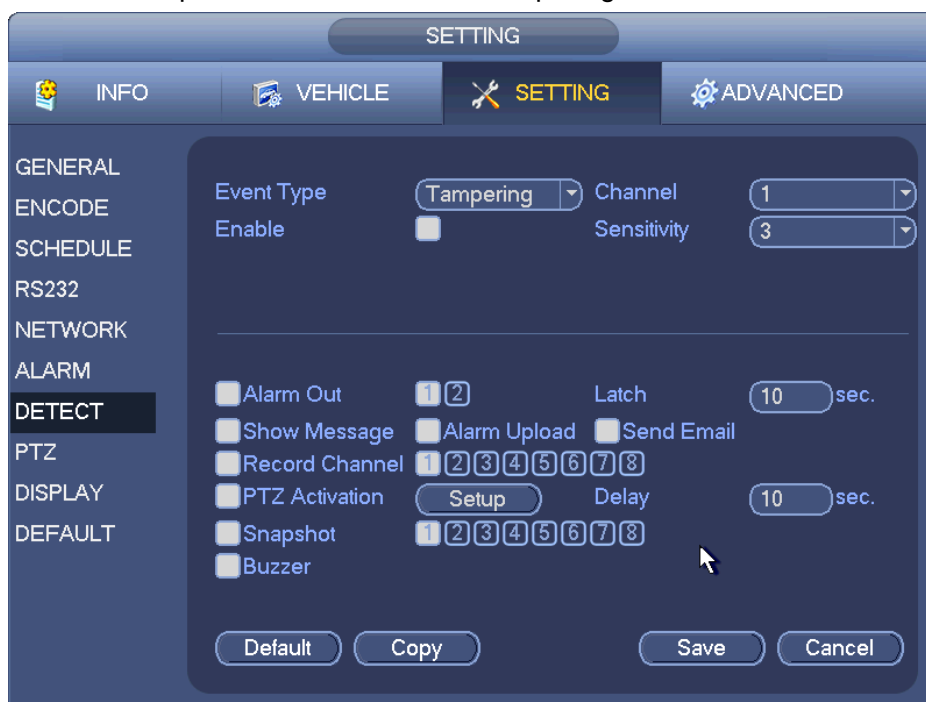

Figure 4-61

4.10.8 PTZ

Note: All the operations here are based on PELCOD protocol. For other protocols, there might be a little difference.

Cable Connection

Please follow the procedures below to go on cable connection

- Connect the dome RS485 port to DVR 485 port.
- Connect dome video output cable to DVR video input port.
- Connect power adapter to the dome.

PTZ Setup

Note: The camera video should be in the current screen. Before setup, please check the following connections are right:

- PTZ and decoder connection is right. Decoder address setup is right.
- Decoder A (B) line connects with DVR A (B) line.

Boot up the DVR, input user name and password.

In the main menu, click setting, and then click Pan/Tilt Control button. The interface is shown as in Figure 4-62. Here you can set the following items:

- Channel: Select the current camera channel.

- Protocol: Select corresponding PTZ protocol(such as PELCOD)
- Address: Default address is 1.
- Baud rate: Select corresponding baud rate. Default value is 9600.
- Data bit: Select corresponding data bits. Default value is 8.
- Stop bit: Select corresponding stop bits. Default value is 1.
- Parity: There are three options: odd/even/none. Default setup is none.



Figure 4-62

After completing all the setting please click save button.

In one window display mode, right click mouse (click “Fn” Button in the front panel or click “Fn” key in the remote control).

Click Pan/Tilt/Zoom, the interface is shown as below. See Figure 4-63.

Here you can set the following items:

- Step: value ranges fro 1 to 8.
- Zoom
- Focus
- Iris

Please click icon  and  to adjust zoom, focus and iris.



Figure 4-63

In Figure 4-63, please click direction arrows to adjust PTZ position. There are total 8 direction arrows.



Figure 4-64

Here is a sheet for you reference.

Name	Function key	function	Shortcut key	Function key	function	Shortcut Key
Zoom		Wide			Far	
Focus		Near			Far	
Iris		Close			Open	

4.10.9 Display

Display setup interface is shown as below. See Figure 4-65.

- Transparency: Here is for you to adjust transparency. The value ranges from 128 to 255.
- Channel name: Here is for you to set local or remote network camera channel name. System max support 25-digit (The value may vary due to different series).
- Time display: You can select to display time or not when system is playback.
- Car number display: You can select to display plate number or not when system is playback.
- GPS display: System displays GPS information in the screen for your reference. **Please note only the unit of GPS module supports this function.**
- Resolution: There are four options: 1280×1024, 1280×720, 1024×768, 800×600(default). Please note system needs to reboot to active current setup.
- Image enhance: Check the box; you can optimize the margin of the preview video.

Please highlight icon to select the corresponding function.

After completing all the setups please click save button, system goes back to the previous menu.



Figure 4-65

In Figure 4-65, click modify button after channel. You can see an interface shown as in Figure 4-66. Please note all your modification here applies to local end only. You need to refresh web or client-end to get the latest channel name. System max support 25-digital character.



Figure 4-66

- Zero-Channel Encoding (Multiple-Preview) : Click Setup button, you can go to the following interface. See Figure 4-67. Here you can enable and set zero-channel encoding function so that you can view several video sources at one channel.
 - ✧ Enable: This function is disabled by default. Check the box here to enable this function so that you can control the zero-channel encoding function at the WEB.
 - ✧ Compression: System default setup is H.264. You can set according to device capability.
 - ✧ Resolution: System supports D1/HD1/CIF/2CIF/QCIF. The resolution value may vary due to different device capabilities. Please select from the dropdown list.
 - ✧ Frame rate: System supports 1-25(30). The frame rate value may vary due to different device capabilities. Please select from the dropdown list.
 - ✧ Bit Rate: System supports 640/768/896/1024. The bit rate value may vary due to different device capabilities and frame rate setups. Please select from the dropdown list.

- ✧ Save: Click the Save button to save current setup. If this function is disabled, you can not operate zero-channel encoding function at the WEB, the video is black or null even you operate when the function is disabled. After you enabled this function, login the Web and you can select zero-channel encoding mode at the right corner of the

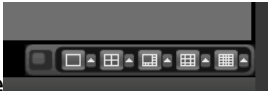
interface . Select a mode; you can view the local preview video.

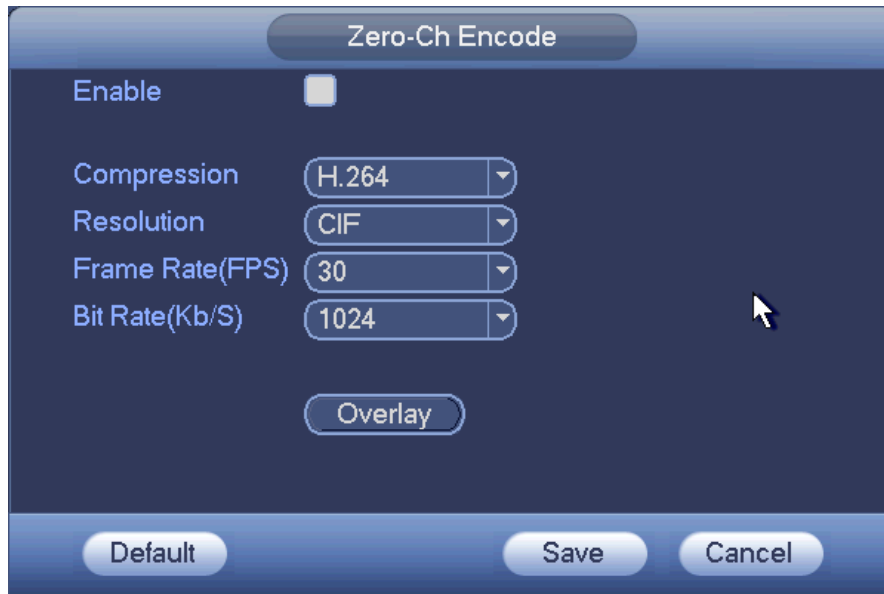



Figure 4-67

4.10.10Default

Click default icon, system pops up a dialogue box. You can highlight  to restore default factory setup.

- Select all
- General
- Encode
- Schedule
- RS232
- Network
- Alarm
- Detect
- Pan/tilt/zoom
- Display
- Channel name

Please highlight icon  to select the corresponding function. See Figure 4-68. After all the setups please click OK button, system goes back to the previous menu.

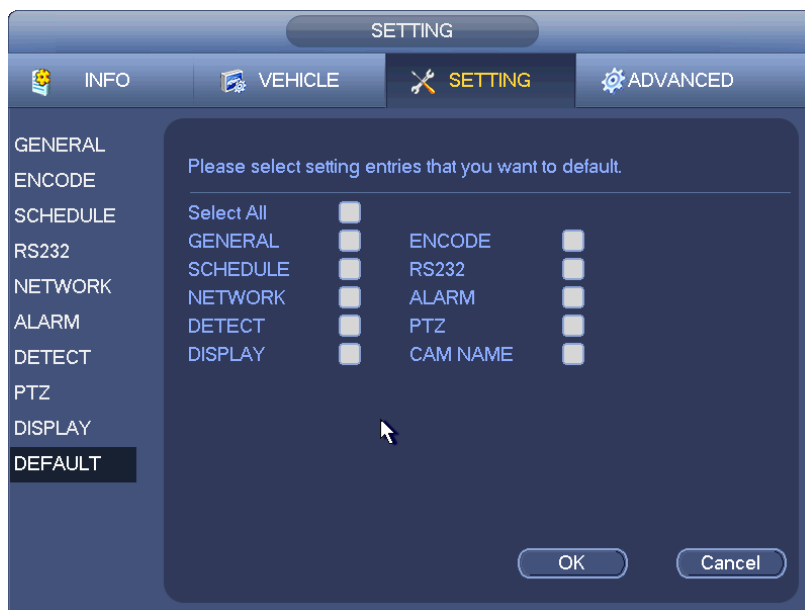

Figure 4-68

Warning!

System menu color, language, video format, user account cannot restore default setup after default operation!

4.11 Advanced

Double click advanced icon in the main window, the interface is shown as below. See Figure 4-69. There are total five items: HDD management, alarm output, record, account, and import/export.

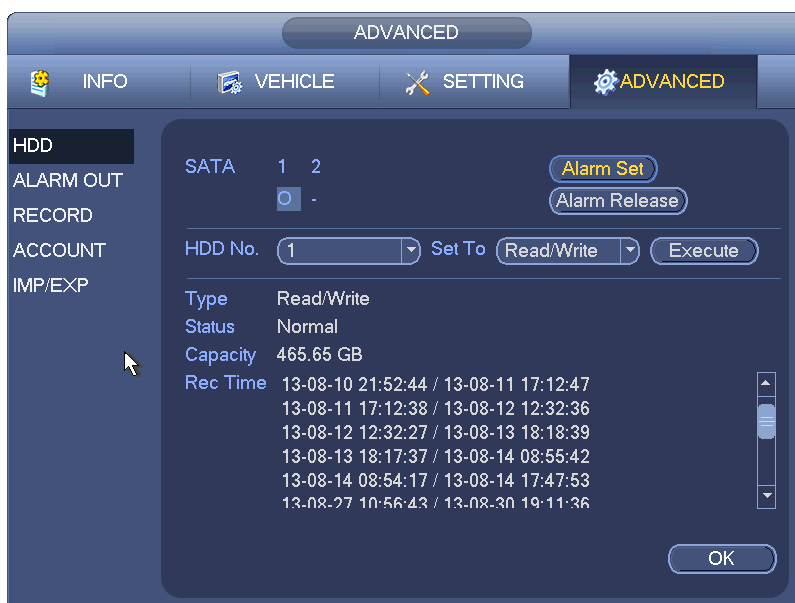

Figure 4-69

4.11.1 HDD Management

Here is for you to view and implement hard disk management. See Figure 4-70.

You can see current HDD type, status, capacity and record time. When HDD is working properly, system is shown as O. When HDD error occurred, system is shown as X.

- Alarm set: Click alarm set button, the interface is shown as below. See Figure 4-71. (This interface is just like the abnormality setup). Please refer to chapter 4.9.6 for detailed information.
- HDD operation: You can select HDD mode from the dropdown list such as read-only or you can erase all data in the HDD. Please note system needs to reboot to get all the modification activated.



Figure 4-70

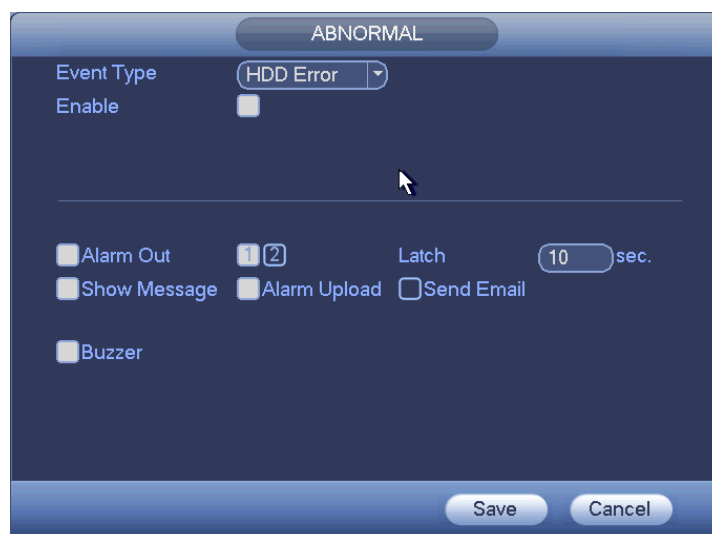

Figure 4-71

4.11.2 Alarm Output

Here is for you to set proper alarm output.

Please highlight icon  to select the corresponding alarm output.

After all the setups please click OK button, system goes back to the previous menu. See Figure 4-72.



Figure 4-72

4.11.3 Manual Record

Note:

You need to have proper rights to implement the following operations. Please make sure the HDD has been properly installed.

4.11.3.1 Manual record menu

Right click mouse or in the main menu, Advanced->Manual Record.

Manual record menu is shown as in Figure 4-73.

4.11.3.2 Basic operation

There are two streams: main stream/extra stream. There are three statuses: schedule/manual/stop. Please highlight icon“o” to select corresponding channel.

- Manual: The highest priority. After manual setup, all selected channels will begin ordinary recording.
- Schedule: Channel records as you have set in recording setup (Main Menu->Setting->Schedule)
- Stop: All channels stop recording.

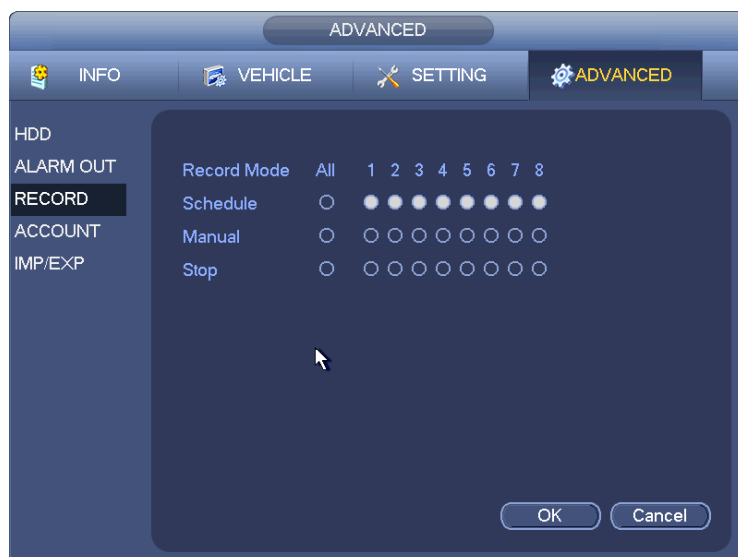

Figure 4-73

4.11.3.3 Enable/disable record

Please check current channel status: “○” means it is not in recording status, “●” means it is in recording status.

You can use mouse or direction key to highlight channel number. See Figure 4-74.



Figure 4-74

4.11.3.4 Enable all channel recording

Highlight ○ below All, you can enable all channel recording.

- All channel schedule record

Please highlight “ALL” after “Schedule”. See Figure 4-75.

When system is in schedule recording, all channels will record as you have previously set (Main menu->Setting->Schedule).

The corresponding indication light in front panel will turn on.



Figure 4-75

- All channel manual record

Please highlight “ALL” after “Manual.” See Figure 4-76.

When system is in manual recording, all scheduled set up you have set in will be null ((Main menu->Setting->Schedule)).

You can see indication light in front panel turns on, system begins manual record now.



Figure 4-76

4.11.3.5 Stop all channel recording

Please highlight “ALL” after “Stop”. See Figure 4-77.

System stops all channel recording no matter what mode you have set in the menu (Main menu->Setting->Schedule)



Figure 4-77

4.11.4 Account

Here is for you to implement account management. See Figure 4-78. Here you can:

- Add new user
- Modify user
- Add group
- Modify group
- Modify password.

For account management please note:

- For the user account name and the user group, the string max length is 6-byte. The backspace in front of or at the back of the string is invalid. There can be backspace in the middle. The string includes the valid character, letter, number, underline, subtraction sign, and dot.
 - System account adopts two-level management: group and user. No limit to group or user amount.
 - For group or user management, there are two levels: admin and user.
 - The user name and group name can consist of eight bytes. One name can only be used once. There are three default administrator users: admin/888888 and hidden user “default”.
 - Hidden user “default” is for system interior use only and can not be deleted. When there is no login user, hidden user “default” automatically login. You can set some rights such as monitor for this user so that you can view some channel view without login.
 - One user should belong to one group. User right can not exceed group right.
 - About reusable function: this function allows multiple users use the same account to login.
- After all the setups please click save button, system goes back to the previous menu.



Figure 4-78

4.11.4.1 Modify Password

Click password button, the interface is shown as in Figure 4-79.

Here you can modify account password.

Please select the account from the dropdown list, input the old password and then input the new password twice. Click the Save button to confirm current modification.

For the users of user account right, it can modify password of other users.

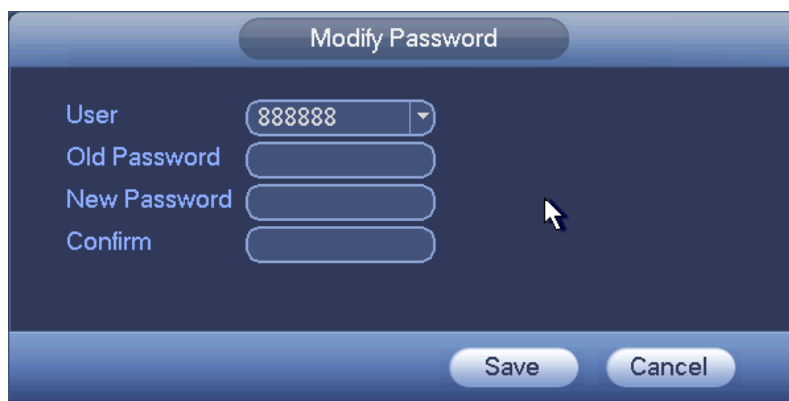

Figure 4-79

4.11.4.2 Add/Modify Group

Click add group button, the interface is shown as below. See Figure 4-80.

Here you can input group name and then input some memo information if necessary.

There are total 60 rights such as control panel, shut down, real-time monitor, playback, record, record file backup, PTZ, user account, system information view, alarm input/output setup, system setup, log view, clear log, upgrade system, control device and etc.

The modify group interface is similar to the Figure 4-80.



Figure 4-80

4.11.4.3 Add/Modify User

Click add user button, the interface is shown as in Figure 4-81.

Please input the user name, password, select the group it belongs to from the dropdown list.

Then you can check the corresponding rights for current user.

For convenient user management, usually we recommend the general user right is lower than the admin account.

The modify user interface is similar to Figure 4-81.

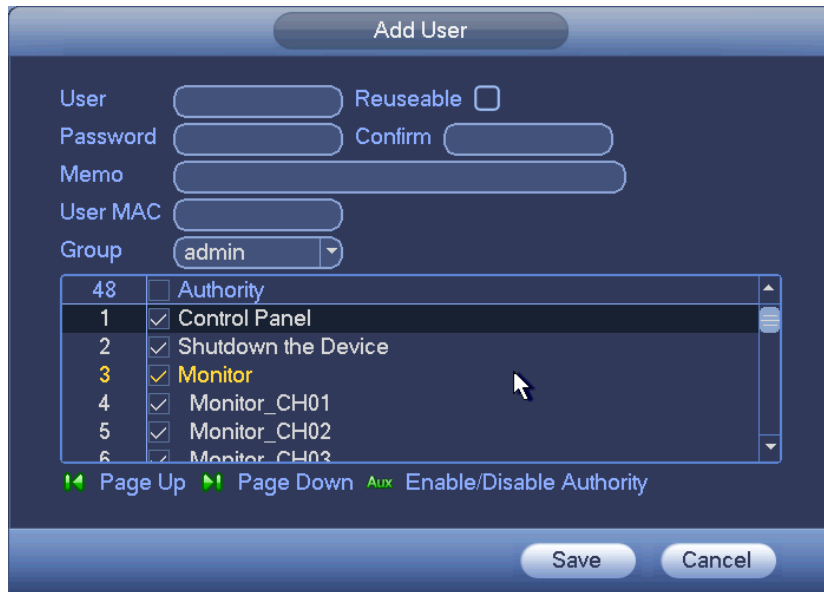

Figure 4-81

4.11.5 Import/Export

The import/export interface is shown as below. See Figure 4-82.

This function allows you to copy current system configuration to other devices. It also supports import, create new folder, and delete folder and etc function.



Figure 4-82

4.12 Backup

DVR supports USB burner, flash disk, portable HDD, eSATA HDD (Need external power supplying and does not support hot swap). Here we introduce USB backup. You can refer to Chapter 5 Web Operation for network download backup operation.

4.12.1 Detect Device

Click backup button, you can see an interface is shown as in Figure 4-83. Here is for you to view device information. You can view backup device name and its total space and free space.

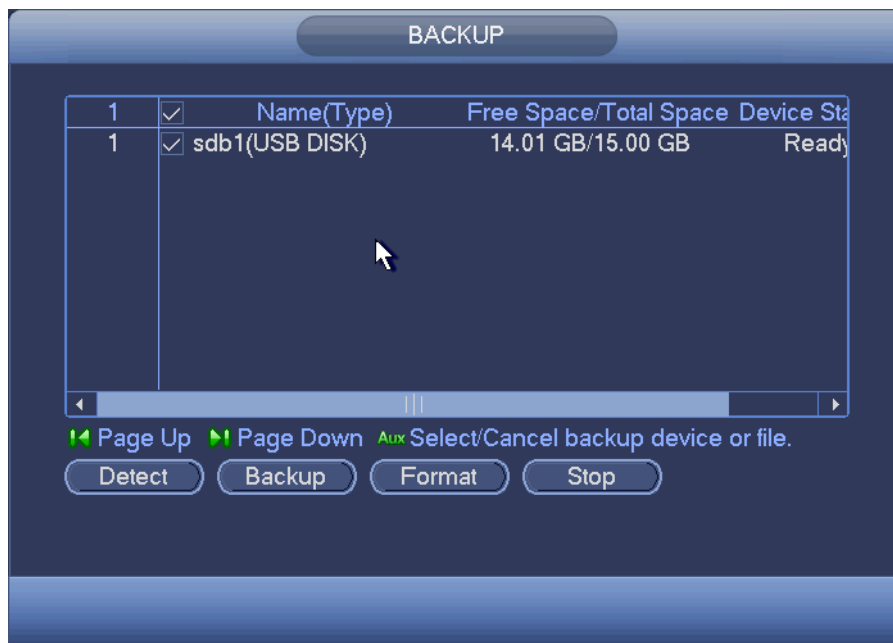

Figure 4-83

4.12.2 Backup

Select backup device and then set channel, file start time and end time.

Click add button, system begins search. All matched files are listed below. System automatically calculates the capacity needed and remained. See Figure 4-84.

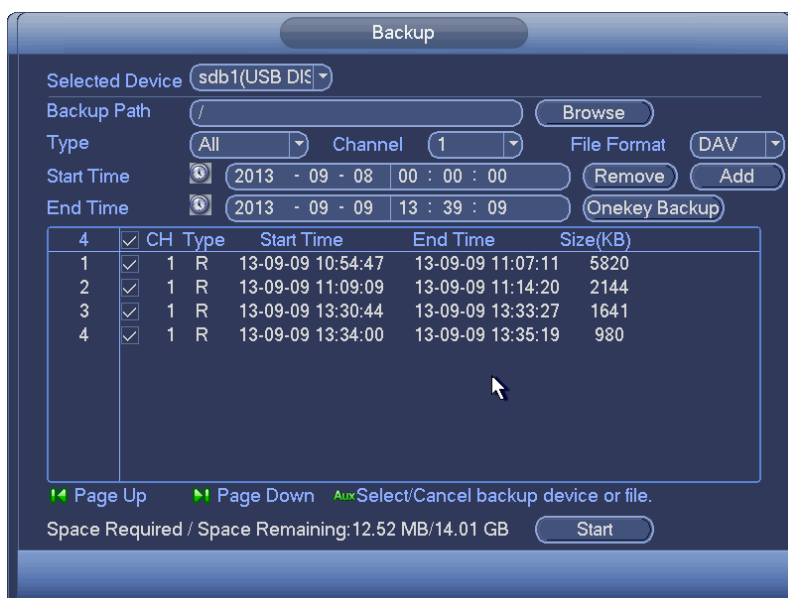

Figure 4-84

System only backup files with a ✓ before channel name. You can use AUX button to check or cancel file.

Click backup button, you can backup selected files. There is a process bar for you reference. See Figure 4-85. Click backup button, system begins burning. At the same time, the backup

button becomes stop button. You can view the remaining time and process bar at the left bottom.



Figure 4-85

When the system completes backup, you can see a dialogue box prompting successful backup.

The file name format usually is: SN_CH+channel number+Time. In the file name, the YDM format is Y+M+D+H+M+S. File extension name is .dav.

Tips:

During backup process, you can click ESC to exit current interface for other operation. The system will not terminate backup process.

Note:

When you click stop button during the burning process, the stop function becomes activated immediately. For example, if there are ten files, when you click stop system just backup five files, system only save the previous 5 files in the device (But you can view ten file names).

4.12.3 One key backup

Insert backup device to the USB port at the front panel and click the F1 button of the remote control, system automatically backup current record files to the device.

4.13 Shutdown

Double click shutdown button, system pops up a dialogue box for you to select. See Figure 4-86.

- Logout menu user: log out menu. You need to input password when you login the next time.
- Restart application: reboot device.
- Shutdown: system shuts down and turns off power.
- Restart system: system begins rebooting.
- Switch user: you can use another account to login.

If you shut down the device, there is a process bar for your reference, system waits for 3 seconds and then shut down (You can not cancel).

Please note, sometimes you need to input the proper password to shut down the device.



Figure 4-86

5 WEB OPERATION

There might be slightly difference in the interface due to different series.

5.1 Network Connection

Before web operation, please check the following items:

- Network connection is right
- DVR and PC network setup is right. Please refer to network setup(Setup ->Network)
- Use order ping `***.***.***.***`(* DVR default IP address is 192.168.1.108) to check connection is OK or not. Usually the return TTL value should be less than 255.
- Open the IE and then input DVR IP address.
- System can automatically download latest web control and the new version can overwrite the previous one.
- If you want to un-install the web control, please run `uninstall webrec3.0.bat`. Or you can go to `C:\Program Files\webrec` to remove single folder. Please note, before you un-install, please close all web pages, otherwise the un-installation might result in error.
- Current series product supports IE and Maxthon browser only.

5.2 Login

Open IE and input DVR address in the address column. For example, if your DVR IP is 10.10.3.16, then please input `http:// 10.10.3.16` in IE address column. See Figure 5-1.

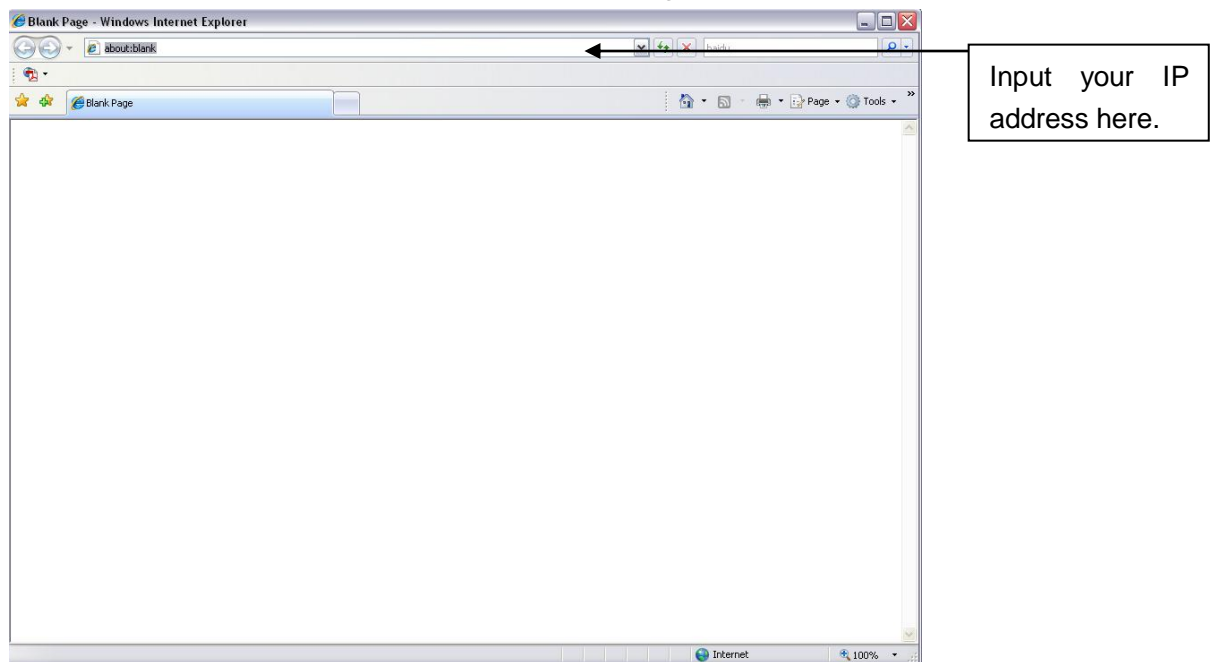

Figure 5-1

System pops up warning information to ask you whether install webrec.cab control or not. Please click yes button.

If you can't download the ActiveX file, please modify your settings as follows. See Figure 5-2.

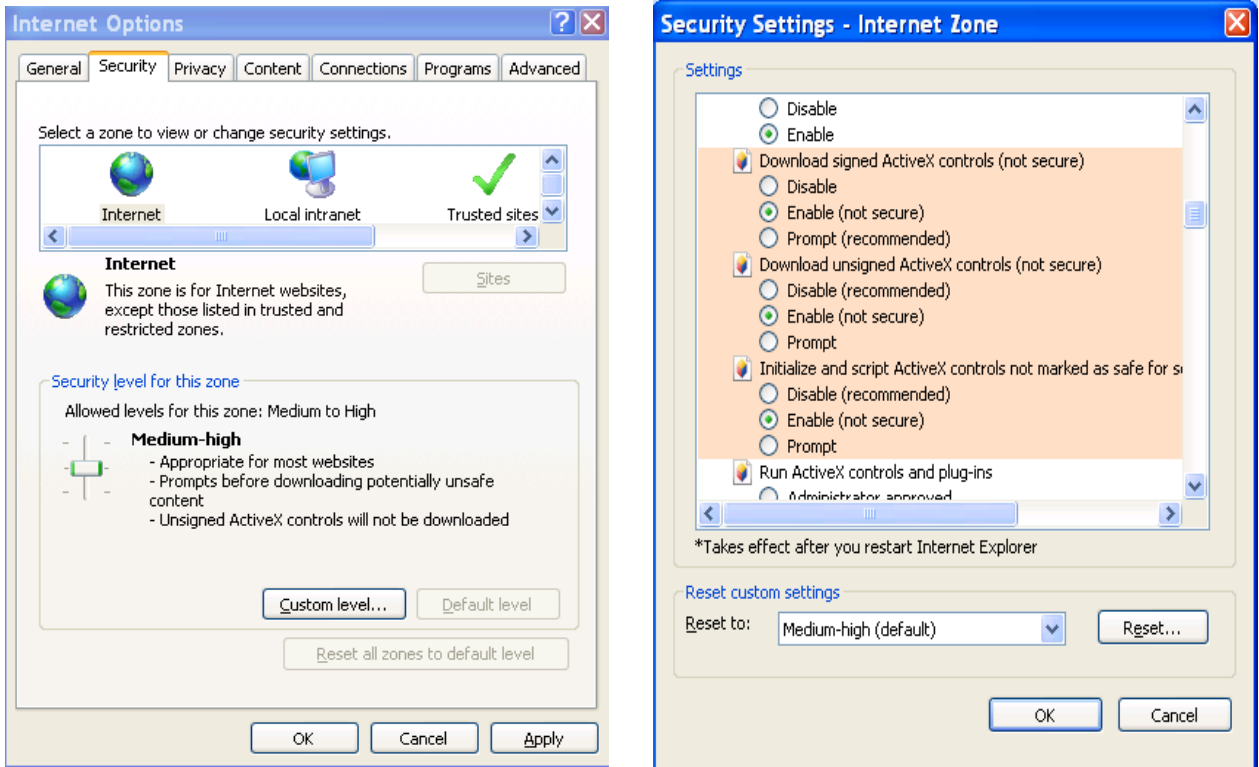

Figure 5-2

After installation, the interface is shown as below. See Figure 5-3.

Please input your user name and password.

Default factory name is **admin** and password is **admin**.

Then you can select the login mode: LAN and WAN.

Note: For security reasons, please modify your password after you first login.

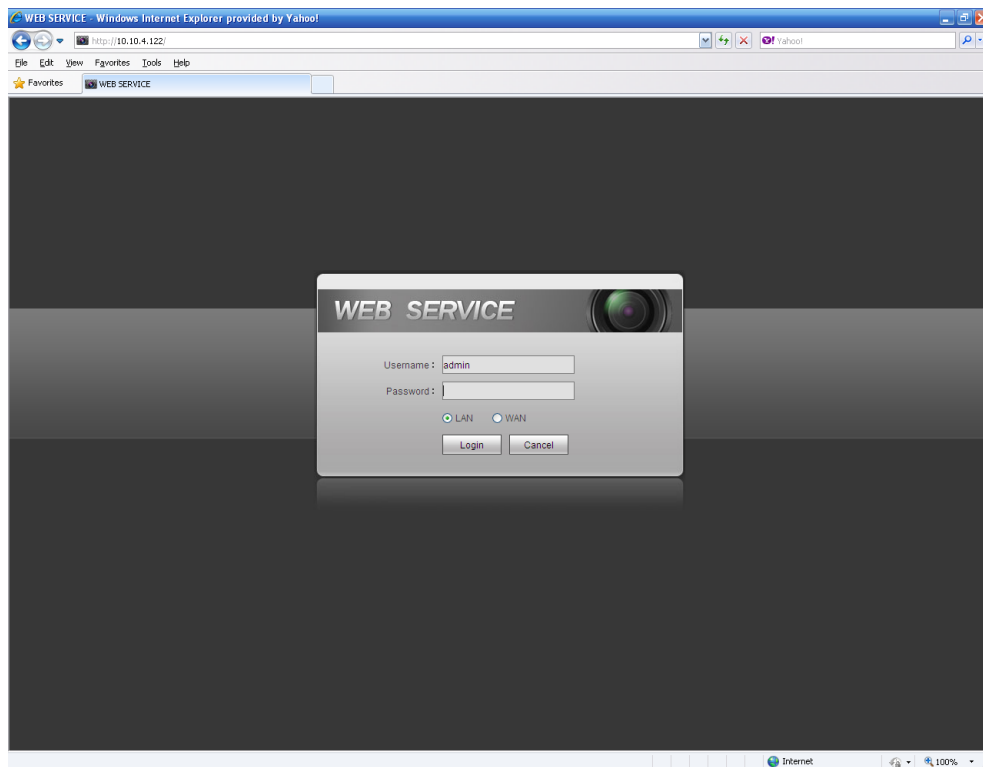

Figure 5-3

5.3 LAN Mode

For the LAN mode, after you logged in, you can see the main window. See Figure 5-9.

This main window can be divided into the following sections.

- Section 1: there are five function buttons: Live (chapter 5.4) , setup (chapter 5.8), search (chapter 5.9), alarm (chapter 5.10), and logout (chapter 5.11).
- Section 2: There are channel number and one button: Start all. Start all button is to enable/disable all-channel real-time monitor. Click it the button becomes yellow. See Figure 5-4.

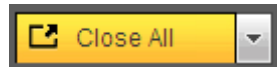

Figure 5-4

Please refer to Figure 5-5 for main stream and extra stream switch information.

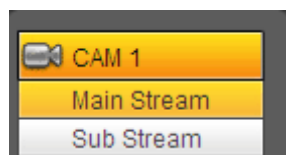

Figure 5-5

- Section 3: Start dialogue button.

You can click this button to enable audio talk. Click 【▼】 to select bidirectional talk mode. There are four options: DEFAULT, G711a, G711u and PCM. After you enable the bidirectional talk, the Start talk button becomes End Talk button and it becomes yellow. See Figure 5-6.

Please note, the audio input port from the device to the client-end is using the first channel audio input port. During the bidirectional talk process, system will not encode the audio data from the 1-channel.

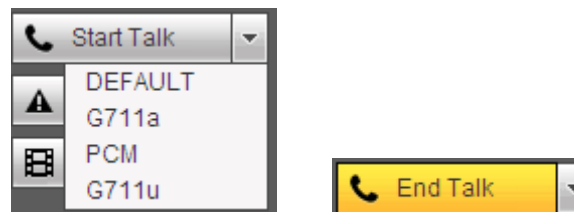

Figure 5-6

- Section 4: Instant record button. Click it, the button becomes yellow and system begins manual record. See Figure 5-7. Click it again, system restores previous record mode..

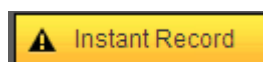

Figure 5-7

- Section 5: Local play button.

The Web can playback the saved (Extension name is dav) files in the PC-end.

Click local play button, system pops up the following interface for you to select local play file. See Figure 5-8.



Figure 5-8

- Section 6: From the left to the right ,you can see video quality/fluency/ full screen/1-window/4-window/6-window/8-window/9-window/13-window/16-window/20-window/25-window/36-window.. You can set video fluency and real-time feature priority.
- Section 7: PTZ operation panel. Please refer to chapter 5.5 for detailed information.
- Section 8: Image setup and alarm setup. Please refer to chapter 5.6 for detailed information.

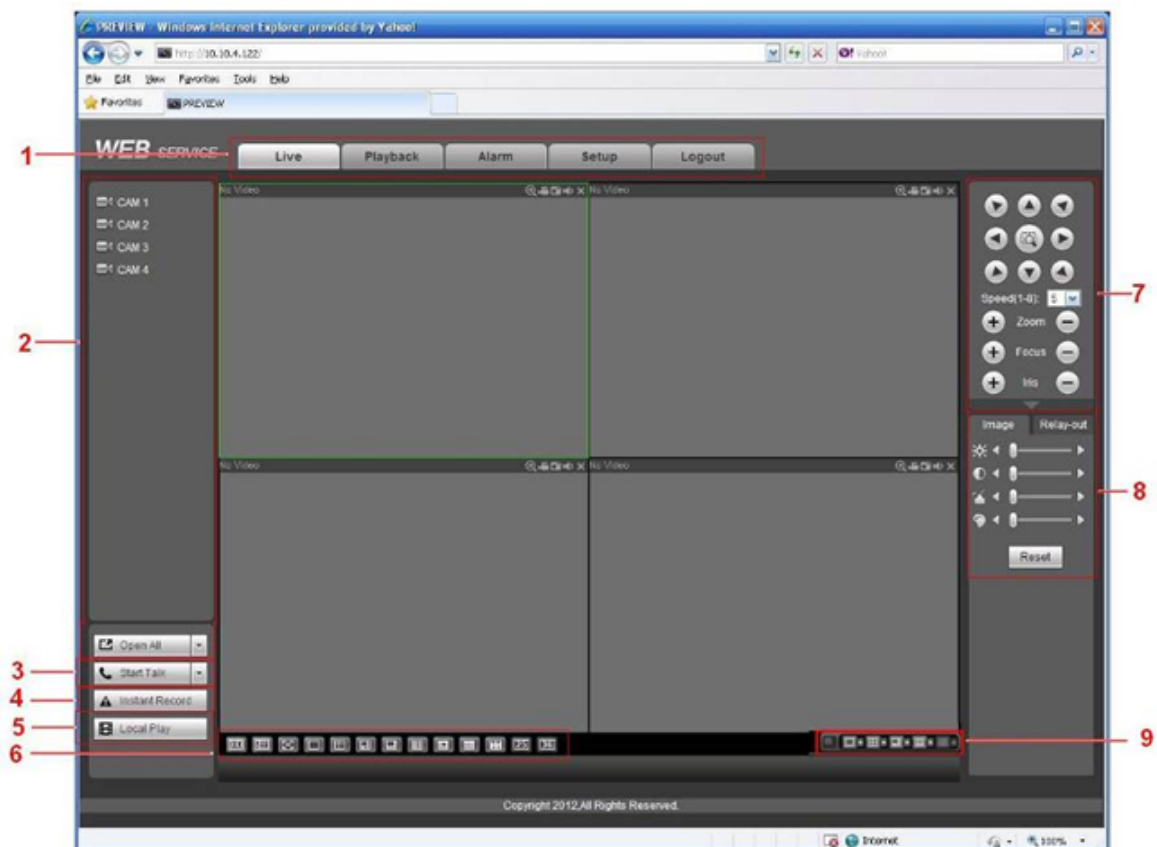

Figure 5-9

5.4 Real-time Monitor

In section 2, left click the channel name you want to view, you can see the corresponding video in current window.

On the top left corner, you can view device IP(10.10.6.129), channel number(1), network monitor bit stream(2466Kbps) and stream type (M=main stream. S=Sub stream). See Figure 5-10.

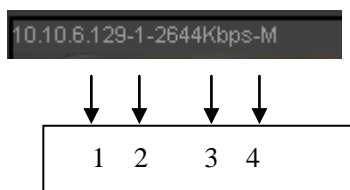

Figure 5-10

On the top right corner, there are six function buttons. See Figure 5-11.

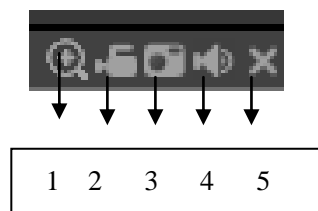

Figure 5-11

- 1: Digital zoom: Click this button and then left drag the mouse in the zone to zoom in. right click mouse system restores original status.
- 2: Local record. When you click local record button, the system begins recording and this button becomes highlighted. You can go to system folder RecordDownload to view the recorded file.
- 3: Snapshot picture. You can snapshot important video. All images are memorized in system client folder PictureDownload (default).
- 4: Audio :Turn on or off audio.(It has no relationship with system audio setup)
- 5: Close video.

5.5 PTZ

Before PTZ operation, please make sure you have properly set PTZ protocol. (Please refer to chapter 5.8.5.7).

There are eight direction keys. In the middle of the eight direction keys, there is a 3D intelligent positioning key.

Click 3D intelligent positioning key, system goes back to the single screen mode. Drag the mouse in the screen to adjust section size. It can realize PTZ automatically.

Please refer to the following sheet for PTZ setup information.

Parameter	Function
Scan	<ul style="list-style-type: none"> ● Select Scan from the dropdown list. ● Click Set button, you can set scan left and right limit. ● Use direction buttons to move the camera to you desired location and then click left limit button. Then move the camera again and then click right limit button to set a right limit.
Preset	<ul style="list-style-type: none"> ● Select Preset from the dropdown list. ● Turn the camera to the corresponding position and Input the preset value. Click Add button to add a preset,.

Parameter	Function
Tour	<ul style="list-style-type: none"> ● Select Tour from the dropdown list. ● Input preset value in the column. Click Add preset button, you have added one preset in the tour. ● Repeat the above procedures you can add more presets in one tour. ● Or you can click delete preset button to remove one preset from the tour.
Pattern	<ul style="list-style-type: none"> ● Select Pattern from the dropdown list. ● You can input pattern value and then click Start button to begin PTZ movement such as zoom, focus, iris, direction and etc. Then you can click Add button to set one pattern.
Aux	<ul style="list-style-type: none"> ● Please input the corresponding aux value here. ● You can select one option and then click AUX on or AUX off button.
Light and wiper	You can turn on or turn off the light/wiper.

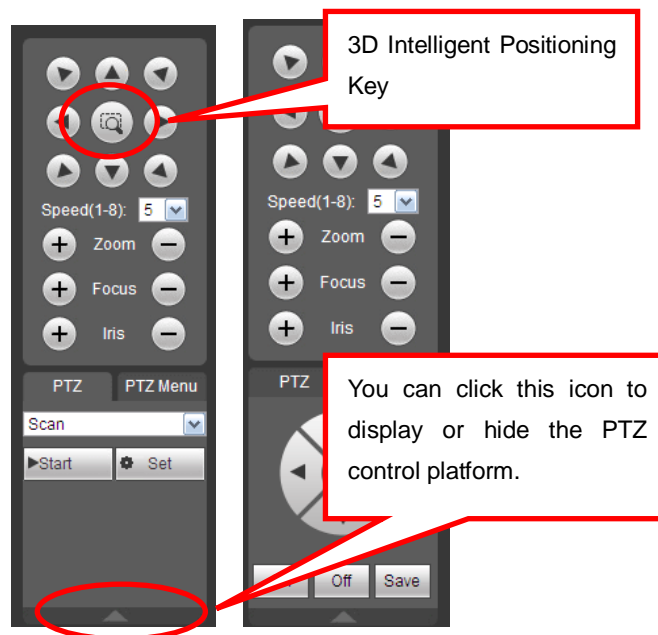

Figure 5-12

5.6 Image/Relay-out

Select one monitor channel video and then click Image button in section 8, the interface is shown as Figure 5-13.

5.6.1 Image

Here you can adjust its brightness, contrast, hue and saturation. (Current channel border becomes green).

Or you can click Reset button to restore system default setup.

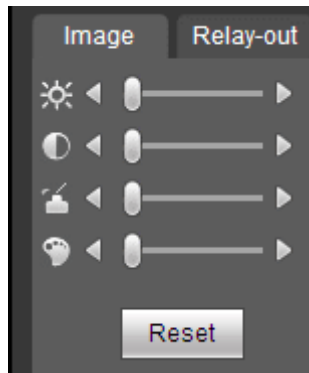

Figure 5-13

5.6.2 Relay output

Here you can select alarm output channel, the select channel alarm mode becomes manual and alarm is enabled. See Figure 5-14. It is corresponding to the alarm output 1 (A1) and alarm output 2 (A2) of the rear panel.



Figure 5-14

5.6.3 Zero-channel encoding

System allows you to preview several channels on one channel. It supports 1/4-window. See Figure 5-15.

Please note only the product of this icon can support current function.



Figure 5-15

5.7 WAN Login

In WAN mode, after you logged in, the interface is shown as below. See Figure 5-16.



Figure 5-16

Please refer to the following contents for LAN and WAN login difference.

- 1) In the WAN mode, system opens the main stream of the first channel to monitor by default. The open/close button on the left pane is null.
- 2) You can select different channel and different monitor mode at the bottom of the interface.
- 3) Multiple-channel monitor, system adopts extra stream to monitor by default. Double click one channel, system switches to single channel and system uses main stream to monitor. You can view there are two icons at the left top corner of the channel number for you reference. M stands for main stream. S stands for sub stream (extra stream).
- 4) If you login via the WAN mode, system does not support alarm activation to open the video function in the Alarm setup interface.

Important

- For multiple-channel monitor mode, system adopts extra stream to monitor by default. You can not modify manually. All channels are trying to synchronize. Please note the synchronization effect still depends on your network environments.
- For bandwidth consideration, system can not support monitor and playback at the same time. System auto closes monitor or playback interface when you are searching setup in the configuration interface. It is to enhance search speed.

5.8 Setup

5.8.1 Channel

5.8.1.1 Conditions

Here you can view device property information. The setups become valid immediately after you set. See Figure 5-17.

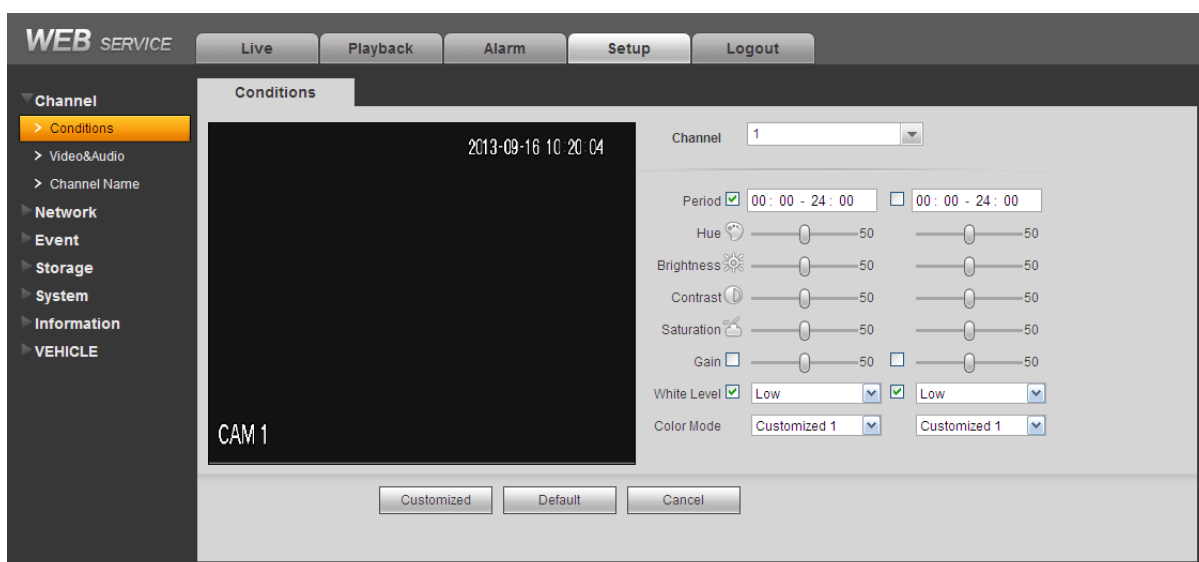

Figure 5-17

Please refer to the following sheet for detailed information.

Parameter	Function
Channel	Please select a channel from the dropdown list.
Period	It divides one day (24 hours) to two periods. You can set different hue, brightness, and contrast for different periods.
Hue	It is to adjust monitor video brightness and darkness level. The default value is 50. The bigger the value is, the large the contrast between the bright and dark section is and vice versa.
Brightness	It is to adjust monitor window brightness. The default value is 50. The larger the number is, the bright the video is. When you input the value here, the bright section and the dark section of the video will be adjusted accordingly. You can use this function when the whole video is too dark or too bright. Please note the video may become hazy if the value is too high. The value ranges from 0 to 100. The recommended value ranges from 40 to 60.
Contrast	It is to adjust monitor window contrast. The value ranges from 0 to 100. The default value is 50. The larger the number is, the higher the contrast is. You can use this function when the whole video bright is OK but the contrast is not proper. Please note the video may become hazy if the value is too low. If this value is too high, the dark section may lack brightness while the bright section may over exposure. The recommended value ranges from 40 to 60.
Saturation	It is to adjust monitor window saturation. The value ranges from 0 to 100. The default value is 50. The larger the number is, the strong the color is. This value has no effect on the general brightness of the whole video. The video color may become too strong if the value is too high. For the grey part of the video, the distortion may occur if the white balance is not accurate. Please note the video may not be

	attractive if the value is too low. The recommended value ranges from 40 to 60.
Gain	The gain adjust is to set the gain value. The smaller the value is, the low the noise is. But the brightness is also too low in the dark environments. It can enhance the video brightness if the value is high. But the video noise may become too clear.
White level	It is to enhance video effect.
Color mode	It includes several modes such as standard, color. You can select corresponding color mode here, you can see hue, brightness, and contrast and etc will adjust accordingly.

5.8.1.2 Video and Audio

5.8.1.2.1 Encode

The encode interface is shown as below. See Figure 5-18.

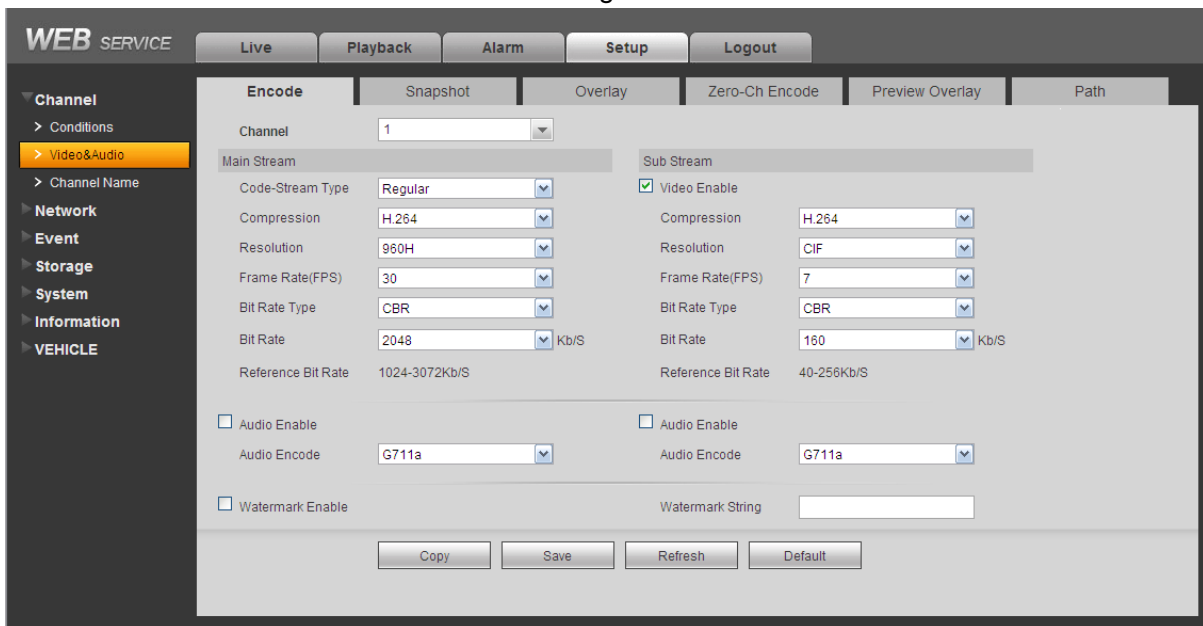

Figure 5-18

Please refer to the following sheet for detailed information.

Parameter	Function
Channel	Please select a channel from the dropdown list.
Video enable	Check the box here to enable extra stream video. This item is enabled by default.
Code stream type	It includes main stream, motion stream and alarm stream. You can select different encode frame rates form different recorded events. System supports active control frame function (ACF). It allows you to record in different frame rates. For example, you can use high frame rate to record important events, record scheduled event in lower frame rate and it allows you to set different frame rates for alarm record.
Compression	The main bit stream supports H.264. The extra stream supports H.264, MJPG.

Resolution	System supports various resolutions, you can select from the dropdown list. The main stream supports 960H/D1/HD1/CIF/2CIF/QCIF and the extra stream supports CIF/QCIF. Please note the option may vary due to different series.
Frame Rate	PAL: 1~25f/s; NTSC: 1~30f/s.
Bit Rate	<ul style="list-style-type: none"> ● Main stream: You can set bit rate here to change video quality. The large the bit rate is , the better the quality is. Please refer to recommend bit rate for the detailed information. ● Extra stream: In CBR, the bit rate here is the max value. In dynamic video, system needs to low frame rate or video quality to guarantee the value. The value is null in VBR mode.
Reference bit rate	Recommended bit rate value according to the resolution and frame rate you have set.
Audio enable	System supports G711a/PCM/G711μ.
Watermark enable	This function allows you to verify the video is tampered or not. Here you can select watermark bit stream, watermark mode and watermark character. Default character is DigitalCCTV. The max length is 85-digit. The character can only include number, character and underline.

5.8.1.2.2 Snapshot

The snapshot interface is shown as in Figure 5-19.

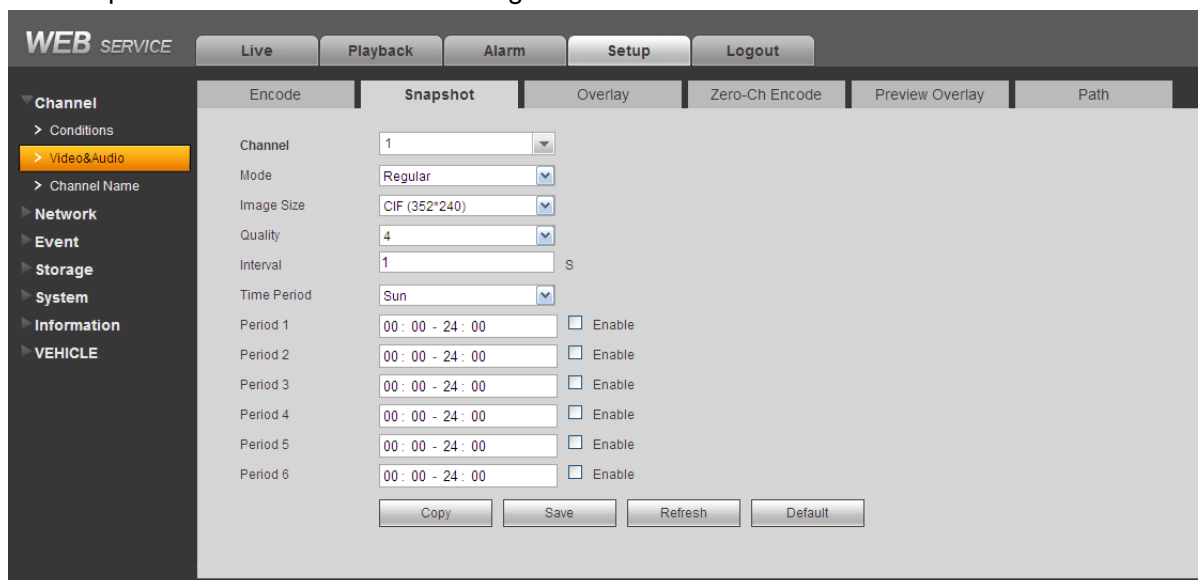

Figure 5-19

Please refer to the following sheet for detailed information.

Parameter	Function
Snapshot type	<p>There are two modes: Timing (schedule) and Event (activation).</p> <ul style="list-style-type: none"> ● Timing snapshot is valid during the specified period you set. ● Activation snapshot only is valid when tampering alarm or

	local activation alarm occurs.
Image size	It is the same with the resolution of the main stream.
Quality	It is to set the image quality. There are six levels.
Interval	It is to set snapshot frequency.
Copy	Click it; you can copy current channel setup to other channel(s).

5.8.1.2.3 Overlay

The video overlay interface is shown as in Figure 5-20.

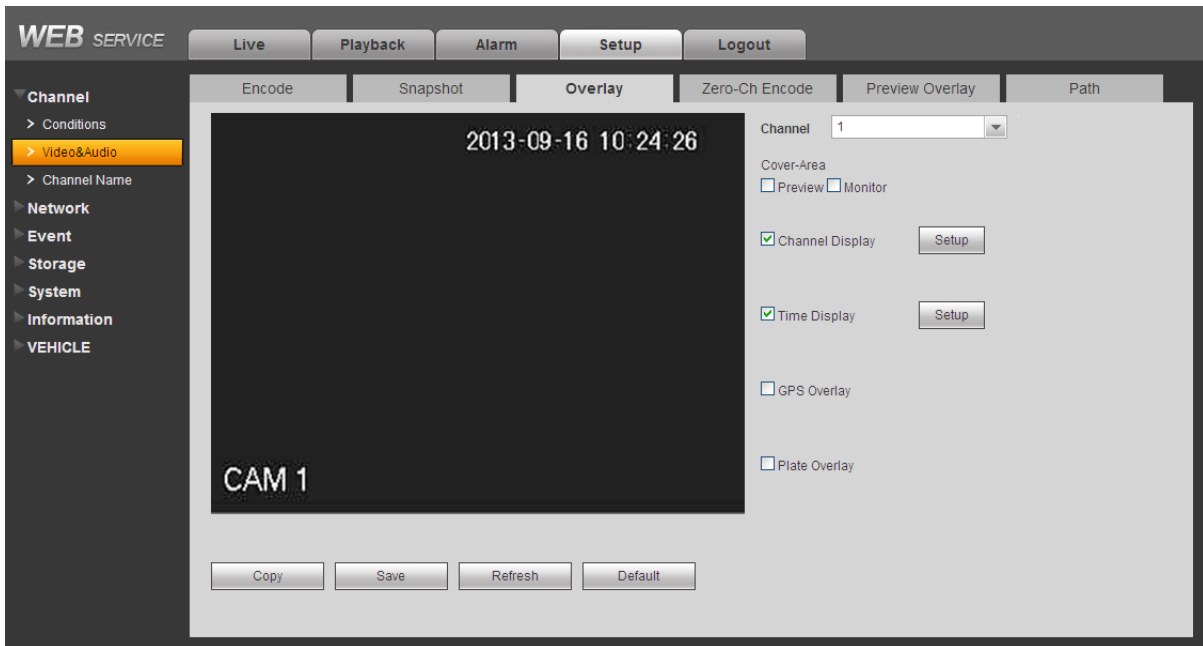

Figure 5-20

Please refer to the following sheet for detailed information.

Parameter	Function
Cover-area (Privacy mask)	Check Preview or Monitor first. Click Set button, you can privacy mask the specified video in the preview or monitor video. System max supports 4 privacy mask zones.
Time Title	You can enable this function so that system overlays time information in video window. You can use the mouse to drag the time title position. You can view time title on the live video of the WEB or the playback video.
Channel Title	You can enable this function so that system overlays channel information in video window. You can use the mouse to drag the channel title position. You can view channel title on the live video of the WEB or the playback video.
GPS Overlay	Overlay GPS information such as (speed, longitude, latitude) on the video.

Plate Overlay	Overlay some plate information on the video.
---------------	----------------------------------------------

5.8.1.2.4 Zero-Ch Encoding

The zero-channel encoding interface is shown as in Figure 5-21.

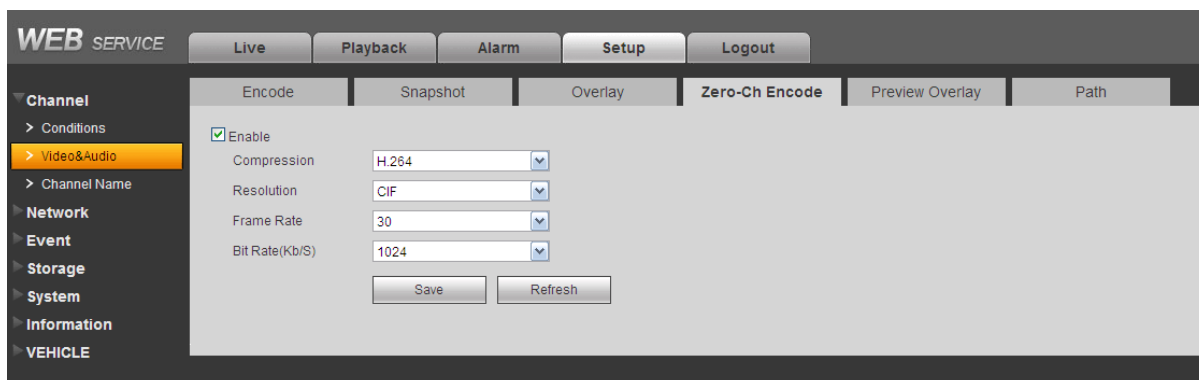

Figure 5-21

Please refer to the following sheet for detailed information.

Parameter	Function
Compression	H.264
Resolution	D1/HD1/CIF/2CIF/QCIF.
Frame Rate	1~25(30).
Bit Rate(kb/s)	640/768/896/1024.

5.8.1.2.5 Preview Overlay

The preview overlay interface is shown as in Figure 5-22. You can overlay time, speed, plate information and etc on the device preview interface and Web monitor video.

The preview overlay is to overlay information on the preview interface or WEB monitor video, the information is not included in record file.

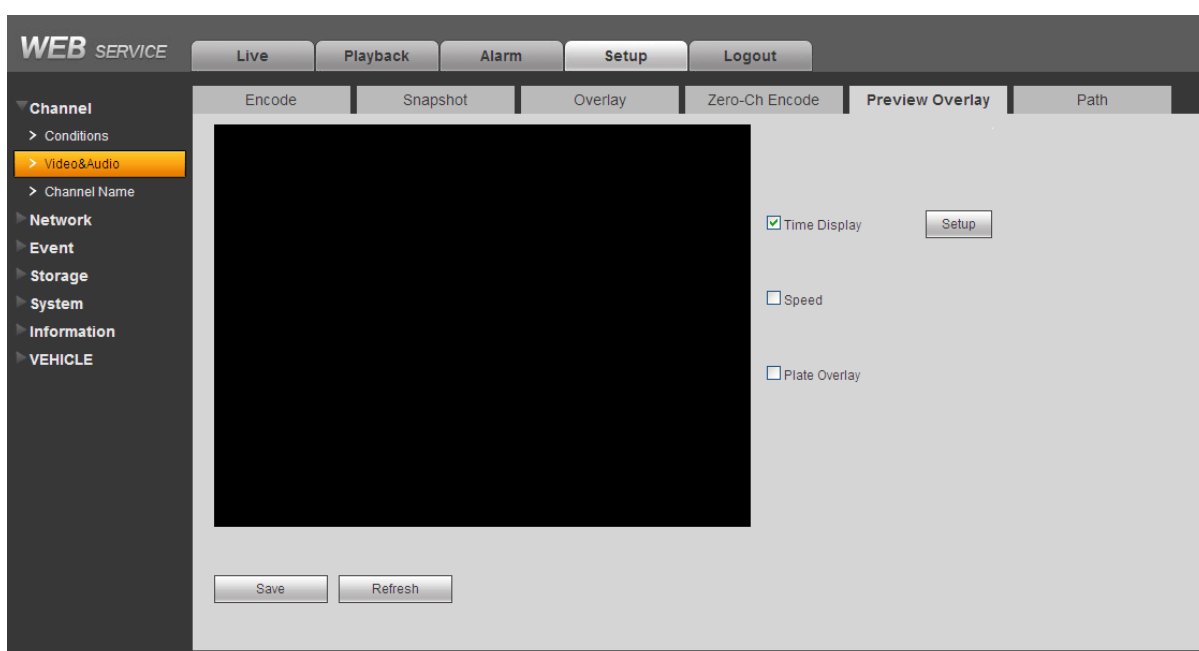

Figure 5-22

5.8.1.2.6 Path

The storage path interface is shown as in Figure 5-23.

Here you can set snap image saved path and the record storage path. The default setup is C:\PictureDownload and C:\RecordDownload.

Please click the Save button to save current setup.

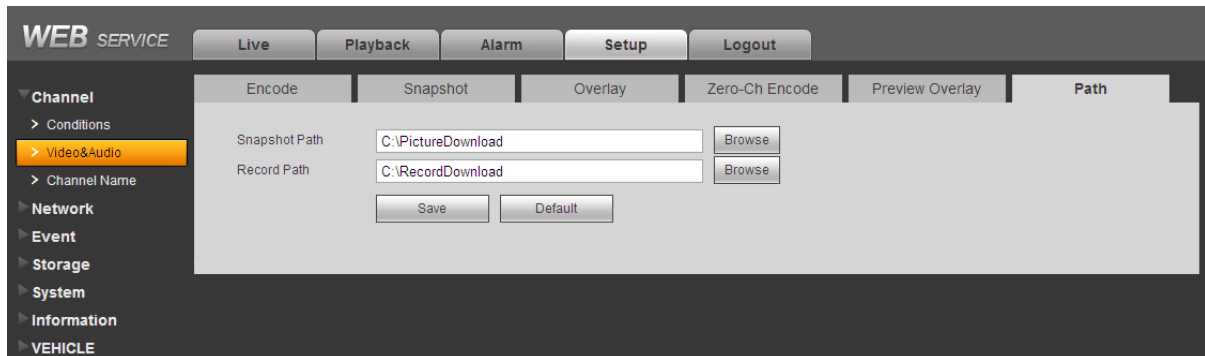

Figure 5-23

5.8.1.3 Channel Name

Here you can set channel name. See Figure 5-24.

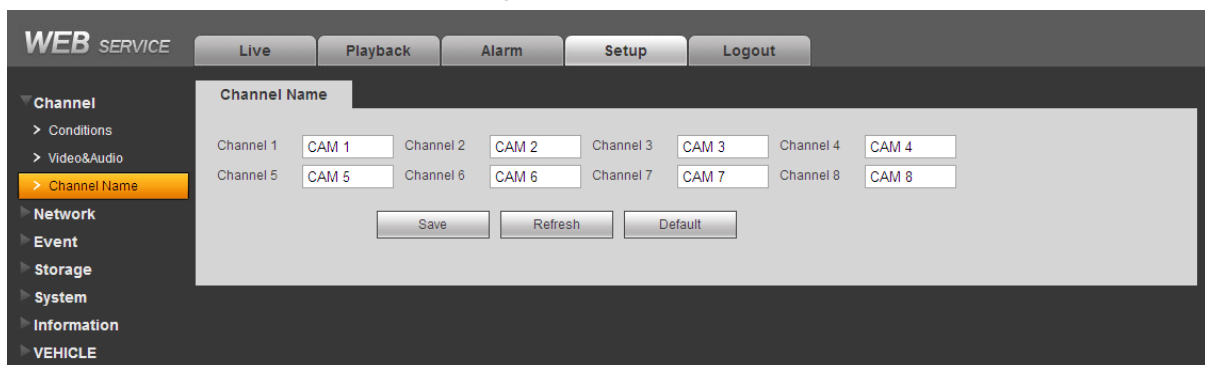

Figure 5-24

5.8.2 Network

5.8.2.1 TCP/IP

The TCP/IP interface is shown as in Figure 5-25.

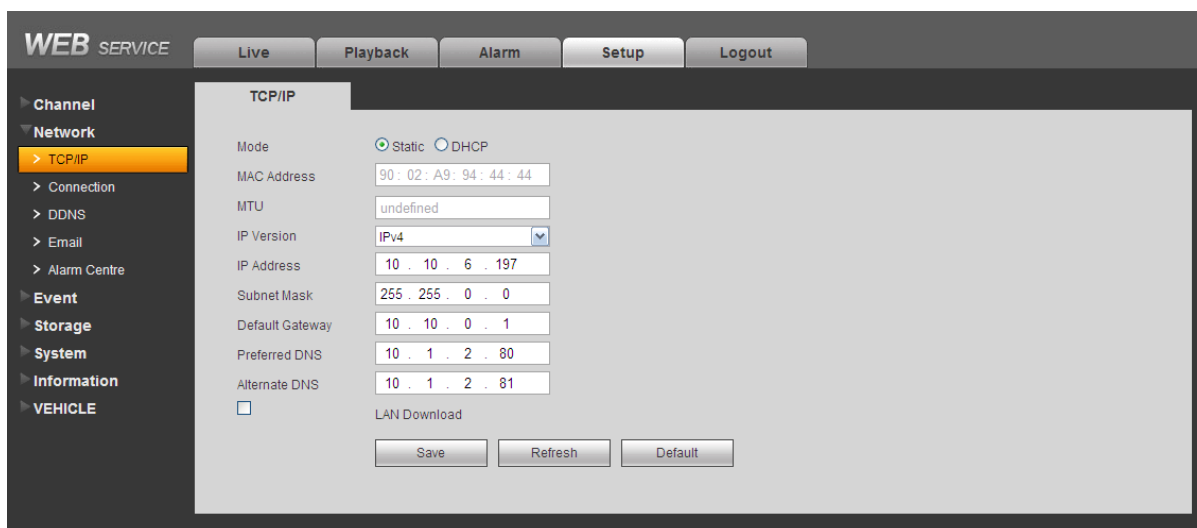

Figure 5-25

Please refer to the following sheet for detailed information.

Parameter	Function
Mode	<p>There are two modes: static mode and the DHCP mode.</p> <ul style="list-style-type: none"> ● The IP/submask/gateway are null when you select the DHCP mode to auto search the IP. ● If you select the static mode, you need to set the IP/submask/gateway manually. ● If you select the DHCP mode, you can view the IP/submask/gateway from the DHCP. ● If you switch from the DHCP mode to the static mode, you need to reset the IP parameters.
Mac Address	It is to display host Mac address.
MTU	Max transmission unit.
IP Version	It is to select IP version. IPV4 or IPV6. You can access the IP address of these two versions.
IP Address	Please use the keyboard to input the corresponding number to modify the IP address and then set the corresponding subnet mask and the default gateway.
Subnet Mask	Input subnet mask according to your device IP.
Default Gateway	Input default gateway according to your device IP.
Preferred DNS	DNS IP address.
Alternate DNS	Alternate DNS IP address.
For the IP address of IPv6 version, default gateway, preferred DNS and alternate DNS, the input value shall be 128-digit. It shall not be left in blank.	
LAN load	System can process the downloaded data first if you enable this function. The download speed is 1.5X or 2.0X of the normal speed.

5.8.2.2 Connection

The connection interface is shown as in Figure 5-26.

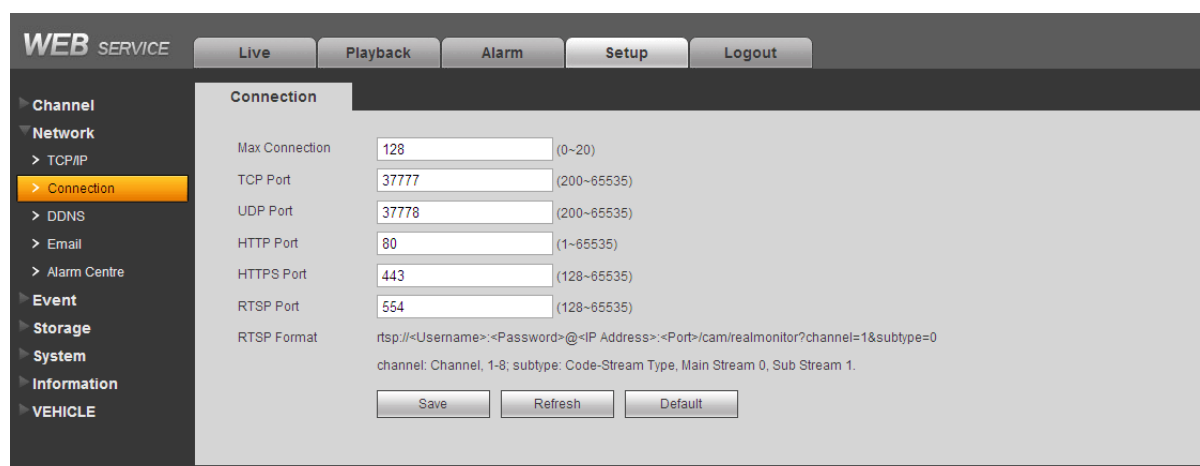

Figure 5-26

Please refer to the following sheet for detailed information.

Parameter	Function
Max connection	It is the max Web connection for the same device. The value ranges from 0 to 128. The default setup is 128.
TCP port	The default value is 37777. You can input the actual port number if necessary.
UDP port	The default value is 37778. You can input the actual port number if necessary.
HTTP port	The default value is 80. You can input the actual port number if necessary.
HTTPS	The default value is 443. You can input the actual port number if necessary.
RTSP port	The default value is 554.

5.8.2.3 DDNS

The DDNS interface is shown as in Figure 5-27.

The DDNS is to set to connect the various servers so that you can access the system via the server. Please go to the corresponding service website to apply a domain name and then access the system via the domain. It works even your IP address has changed.

Please select DDNS from the dropdown list (Multiple choices). Before you use this function, please make sure your purchased device support current function.

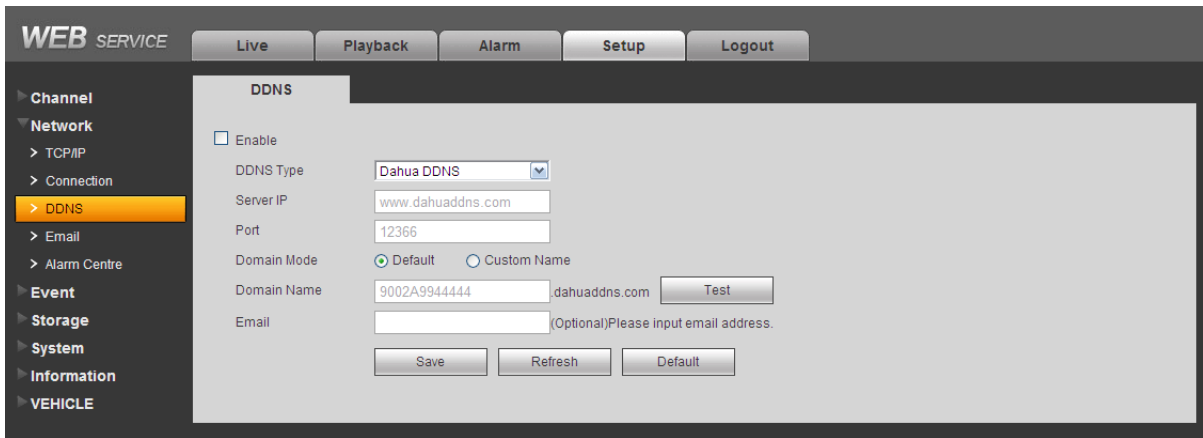

Figure 5-27

Please refer to the following sheet for detailed information.

Parameter	Function
Server Type	You can select DDNS protocol from the dropdown list and then enable DDNS function.
Server IP	DDNS server IP address
Server Port	DDNS server port.
Domain Name	Your self-defined domain name.
User	The user name you input to log in the server.
Password	The password you input to log in the server.
Update period	Device sends out alive signal to the server regularly. You can set interval value between the device and DDNS server here.

Quick DDNS and Client-end Introduction

1) Background Introduction

Device IP is not fixed if you use ADSL to login the network. The DDNS function allows you to access the DVR via the registered domain name. Besides the general DDNS, the quick DDNS works with the device from the manufacturer so that it can add the extension function.

2) Function Introduction

The quick DDNS client has the same function as other DDNS client end. It realizes the bonding of the domain name and the IP address. Right now, current DDNS server is for our own devices only. You need to refresh the bonding relationship of the domain and the IP regularly. There is no user name, password or the ID registration on the server. At the same time, each device has a default domain name (Generated by MAC address) for your option. You can also use customized valid domain name (has not registered.).

3) Operation

Before you use Quick DDNS, you need to enable this service and set proper server address, port value and domain name.

- Server address: www.quickddns.com
- Port number: 80
- Domain name: There are two modes: Default domain name and customized domain name.

Except default domain name registration, you can also use customized domain name (You can input your self-defined domain name.) After successful registration, you can use domain name to login installed of the device IP.

- User name: It is optional. You can input your commonly used email address.

Important

- Do not register frequently. The interval between two registrations shall be more than 60 seconds. Too many registration requests may result in server attack.
- System may take back the domain name that is idle for one year. You can get a notification email before the cancel operation if your email address setup is OK.

5.8.2.4 Email

The email interface is shown as in Figure 5-28.

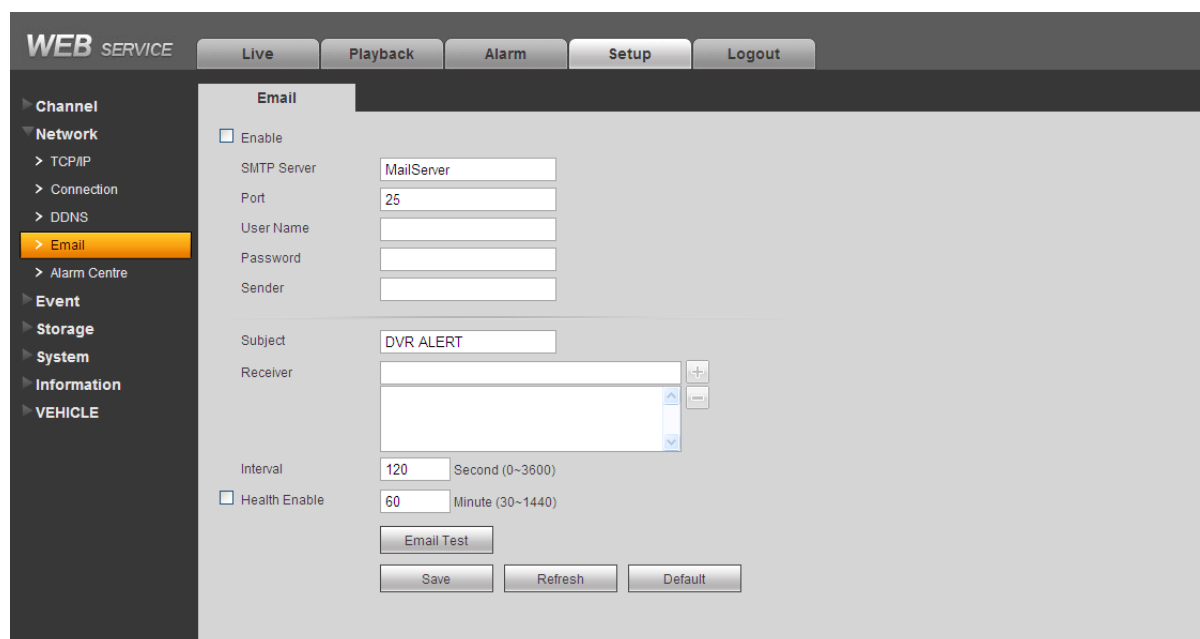

Figure 5-28

Please refer to the following sheet for detailed information.

Parameter	Function
Enable	Please check the box here to enable email function.
SMTP Server	Input server address and then enable this function.
Port	Default value is 25. You can modify it if necessary.
Anonymity	For the server supports the anonymity function. You can auto login anonymously. You do not need to input the user name, password and the sender information.
User Name	The user name of the sender email account.
Password	The password of sender email account.
Sender	Sender email address.
Authentication (Encryption mode)	You can select SSL or none.

Parameter	Function
Subject	Input email subject here.
Attachment	System can send out the email of the snapshot picture once you check the box here.
Receiver	Input receiver email address here. Max three addresses. It supports SSL, TLS email box.
Interval	The send interval ranges from 0 to 3600 seconds. 0 means there is no interval. Please note system will not send out the email immediately when the alarm occurs. When the alarm or the abnormality event activates the email, system sends out the email according to the interval you specified here. This function is very useful when there are too many emails activated by the abnormality events, which may result in heavy load for the email server.
Health mail enable	Please check the box here to enable this function.
Update period (interval)	This function allows the system to send out the test email to check the connection is OK or not. Please check the box to enable this function and then set the corresponding interval. System can send out the email regularly as you set here.
Email test	The system will automatically sent out a email once to test the connection is OK or not .Before the email test, please save the email setup information.

5.8.2.5 Alarm Centre

The alarm centre interface is shown as below. See Figure 5-29.

This interface is reserved for you to develop. System can upload alarm signal to the alarm centre when local alarm occurs.

Before you use alarm centre, please set server IP, port and etc. When an alarm occurs, system can send out data as the protocol defined, so the client-end can get the data.

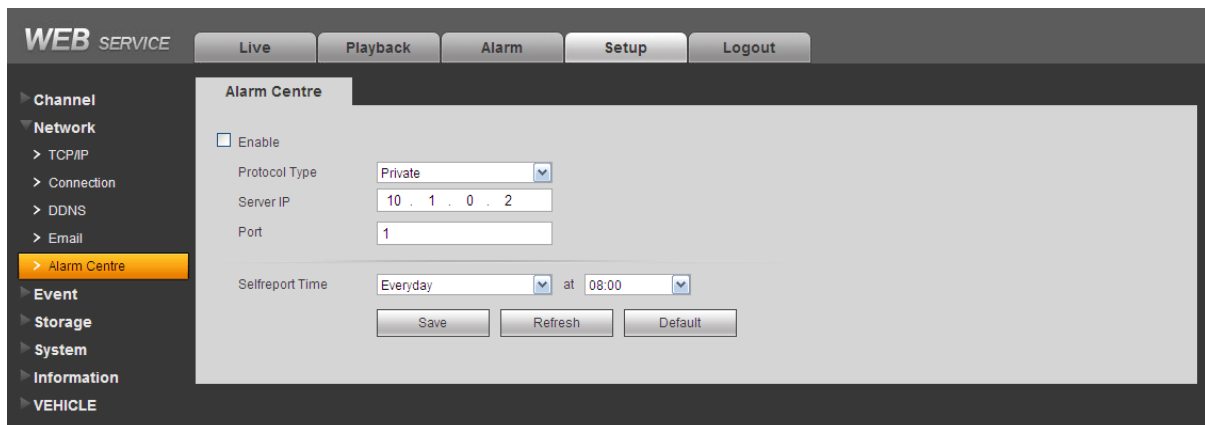

Figure 5-29

Please refer to the following sheet for detailed information.

Parameter	Function
Server IP	Alarm centre IP address.
Port	Alarm centre port value.
Self-report time	System auto report current alarm status at the specified time.

5.8.3 Event

5.8.3.1 Video detect

5.8.3.1.1 Video loss

The video loss interface is shown as in Figure 5-30.

This function allows you to be informed when video loss phenomenon occurred. You can enable alarm output channel and then enable show message function.

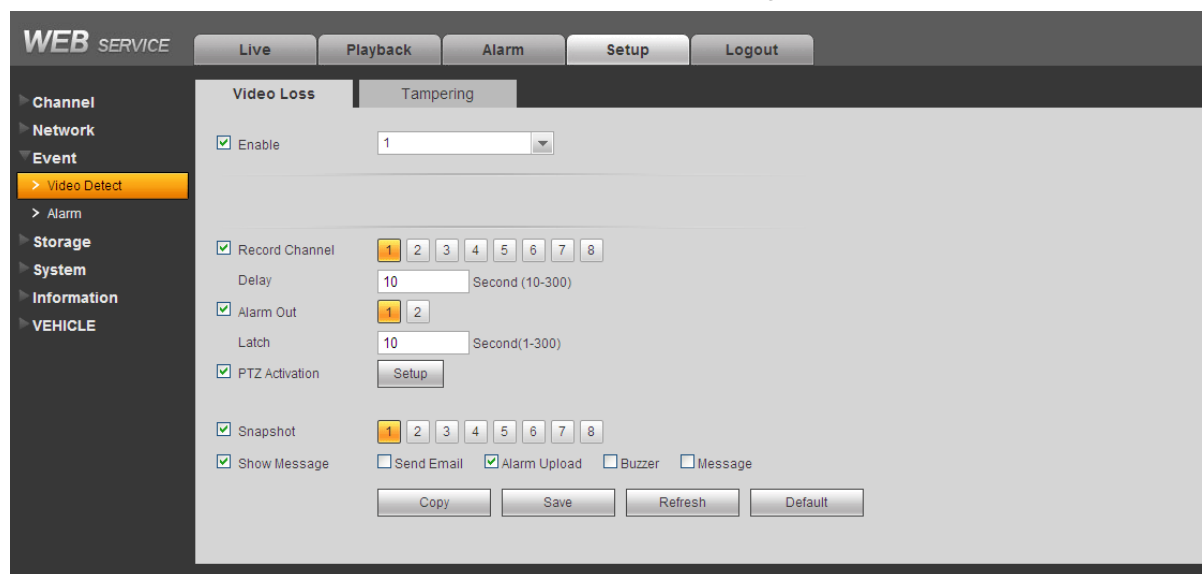

Figure 5-30

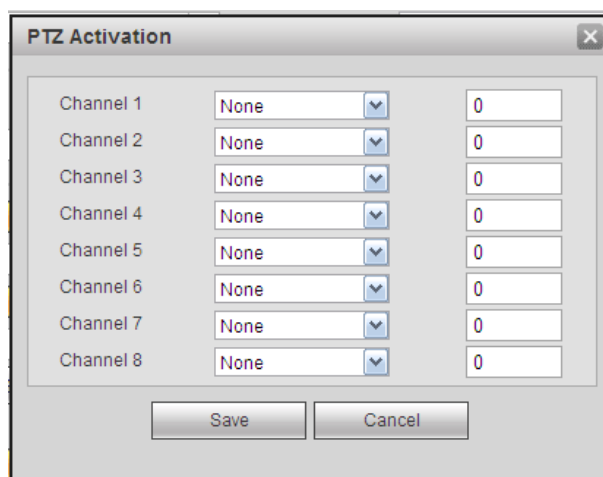

Figure 5-31

Please refer to the following sheet for detailed information.

Parameter	Function
Enable	You need to check the box to enable video loss function. Please select a channel from the dropdown list.
Record channel	System auto activates channel(s) to record once an alarm occurs. Please note you need to set record period and go to Storage-> Schedule to set current channel as schedule record.
Record Delay	System can delay the record for specified time after alarm ended. The value ranges from 10s to 300s.
Alarm out	Enable alarm activation function. You need to select alarm output port so that system can activate corresponding alarm device when an alarm occurs.
Latch	System can delay the alarm output for specified time after an alarm ended. The value ranges from 1s to 300s.
Show message	System can pop up a message to alarm you in the local host screen if you enabled this function.
Buzzer	Check the box here to enable this function. The buzzer beeps when an alarm occurs.
Alarm upload	System can upload the alarm signal to the centre (Including alarm centre).
Message	When 3G network connection is OK, system can send out a message when an video loss occurs.
Send Email	If you enabled this function, System can send out an email to alert you when an alarm occurs.
PTZ Activation	Here you can set PTZ movement when alarm occurs. Such as go to preset X. See Figure 5-31.

5.8.3.1.2 Tampering

The tampering (camera masking) interface is shown as in Figure 5-32.

After analysis video, system can generate a tampering alarm when the detected moving signal reached the sensitivity you set here.

For detailed setups, please refer to chapter 5.8.3.1.1 video loss for detailed information.

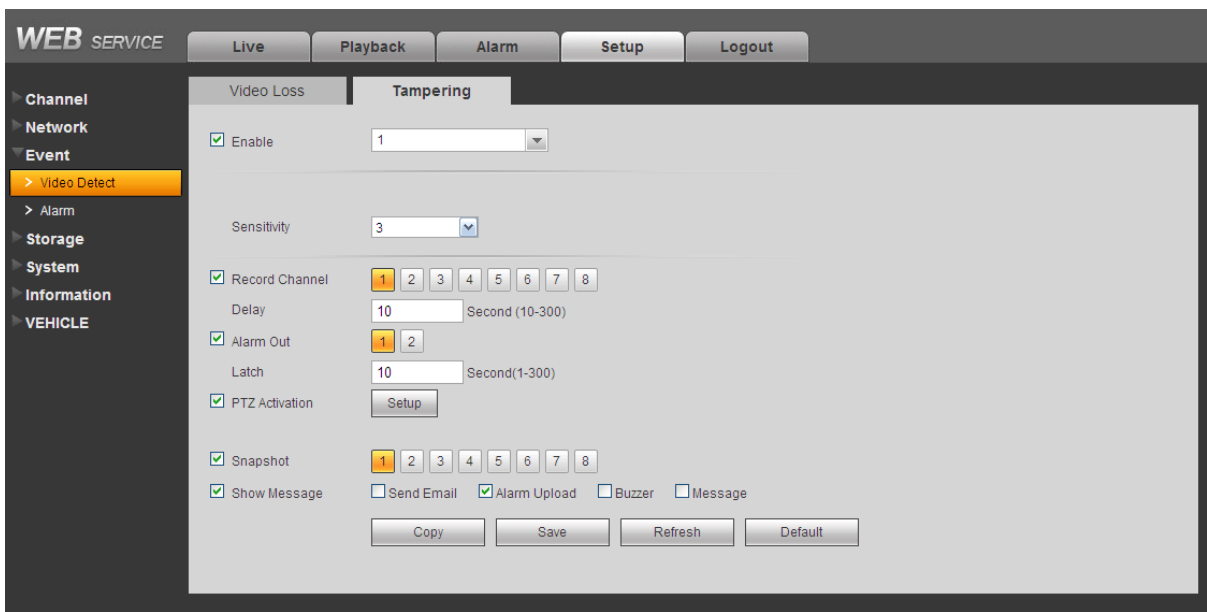

Figure 5-32

5.8.3.2 Alarm

Before operation, please make sure you have properly connected alarm devices such as buzzer. The input mode includes local alarm and network alarm.

5.8.3.2.1 Local Alarm

The local alarm interface is shown as in Figure 5-33.

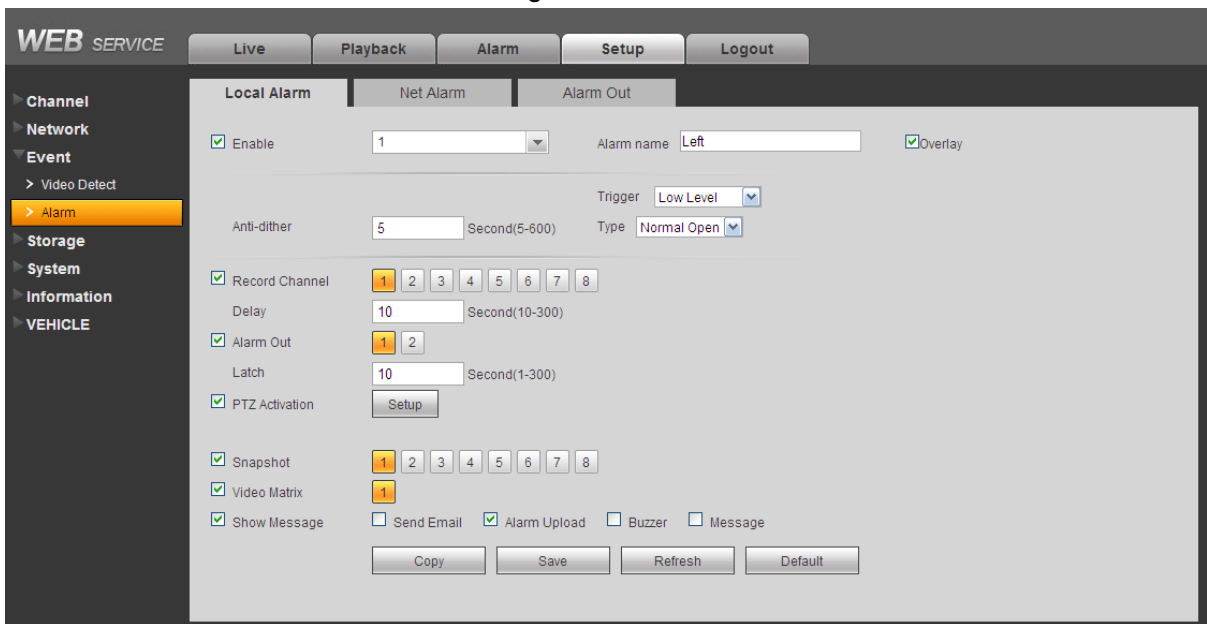

Figure 5-33

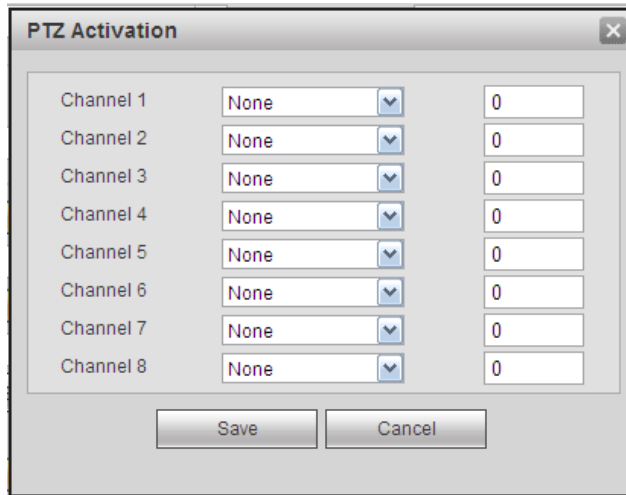

Figure 5-34

Please refer to the following sheet for detailed information.

Parameter	Function
Enable	You need to check the box to enable this function. Please select a channel from the dropdown list.
Period	This function becomes activated in the specified periods. There are six periods in one day. Please draw a circle to enable corresponding period. Select date. If you do not select, current setup applies to today only. You can select all week column to apply to the whole week. Click OK button, system goes back to local alarm interface, please click save button to exit.
Type	Normal open or normal close.
Trigger	Here is for you to set activation mode. There are two options: High/low.
Overlay	Please highlight the box here to enable this function. It can overlay alarm information on the video screen when an alarm occurred.
Anti-dither	System only memorizes one event during the anti-dither period. The value ranges from 5s to 600s.
Record channel	System auto activates channel(s) to record once an alarm occurs. Please note you need to set alarm record period and go to Storage-> Schedule to set current channel as schedule record.
Record Delay	System can delay the record for specified time after alarm ended. The value ranges from 10s to 300s.
Alarm out	Enable alarm activation function. You need to select alarm output port so that system can activate corresponding alarm device when an alarm occurs.
Latch	System can delay the alarm output for specified time after an alarm ended. The value ranges from 1s to 300s.

Parameter	Function
Show message	System can pop up a message to alarm you in the local host screen if you enabled this function.
Buzzer	Check the box here to enable this function. The buzzer beeps when an alarm occurs.
Alarm upload	System can upload the alarm signal to the centre (Including alarm centre).
Send Email	If you enabled this function, System can send out an email to alert you when an alarm occurs.
PTZ Activation	Here you can set PTZ movement when alarm occurs. Such as go to preset X.

5.8.3.2.2 Net Alarm

The network alarm interface is shown as in Figure 5-35.

Network alarm refers to the alarm signal from the network. System does not support anti-dither and sensor type setup. For reset setups, please refer to chapter 5.8.3.2.1.

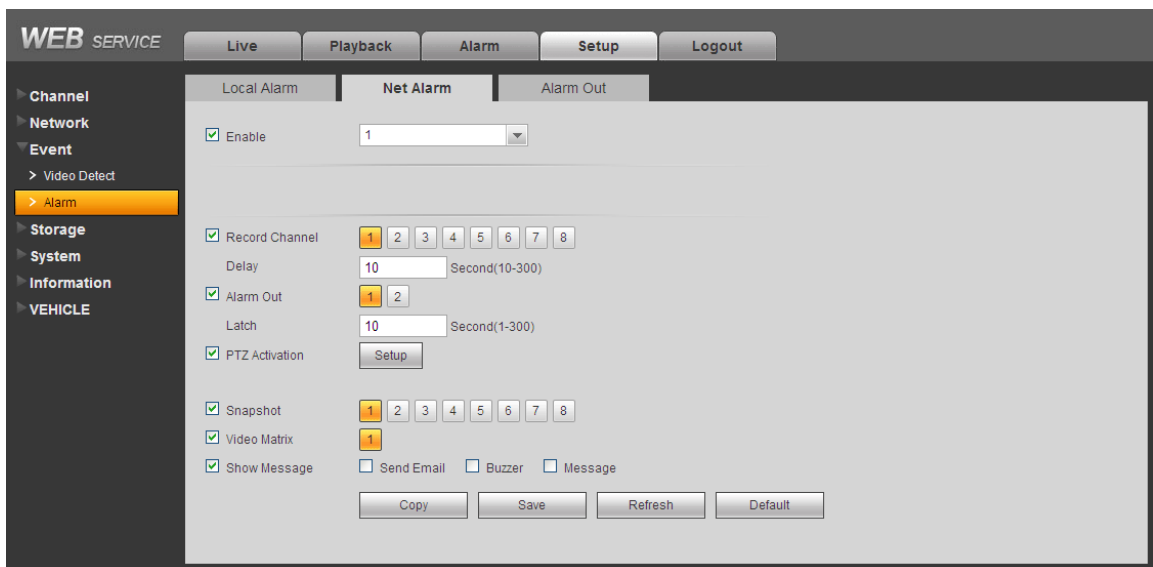

Figure 5-35

5.8.3.2.3 Alarm Out

Here you can set alarm output channel mode: schedule/manual/stop. See Figure 5-36.

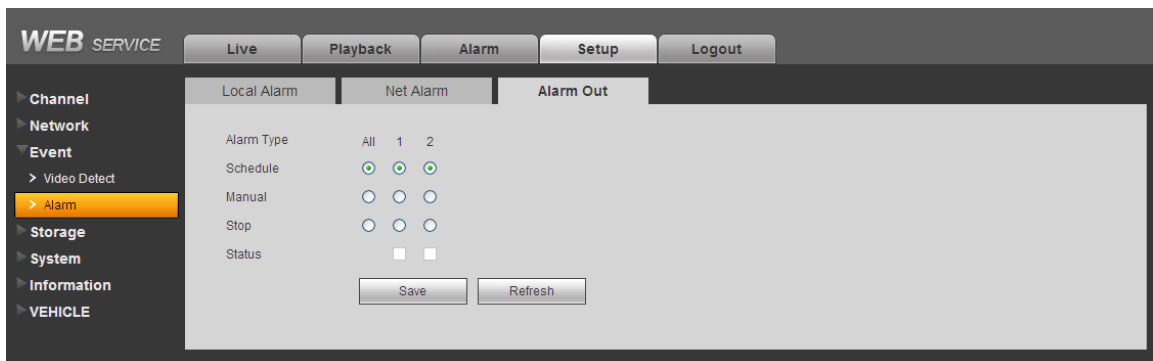

Figure 5-36

5.8.4 Storage

5.8.4.1 Schedule

In this interfaces, you can add or remove the schedule record setup. See Figure 5-37.

There are three record modes: general (auto) and alarm. There are six periods in one day. Please make sure you have enabled the corresponding record mode in the Setup->Storage->Conditions. You can view the current time period setup from the color bar.

- Green color stands for the general record/snapshot.
- Red color stands for the alarm record/snapshot.

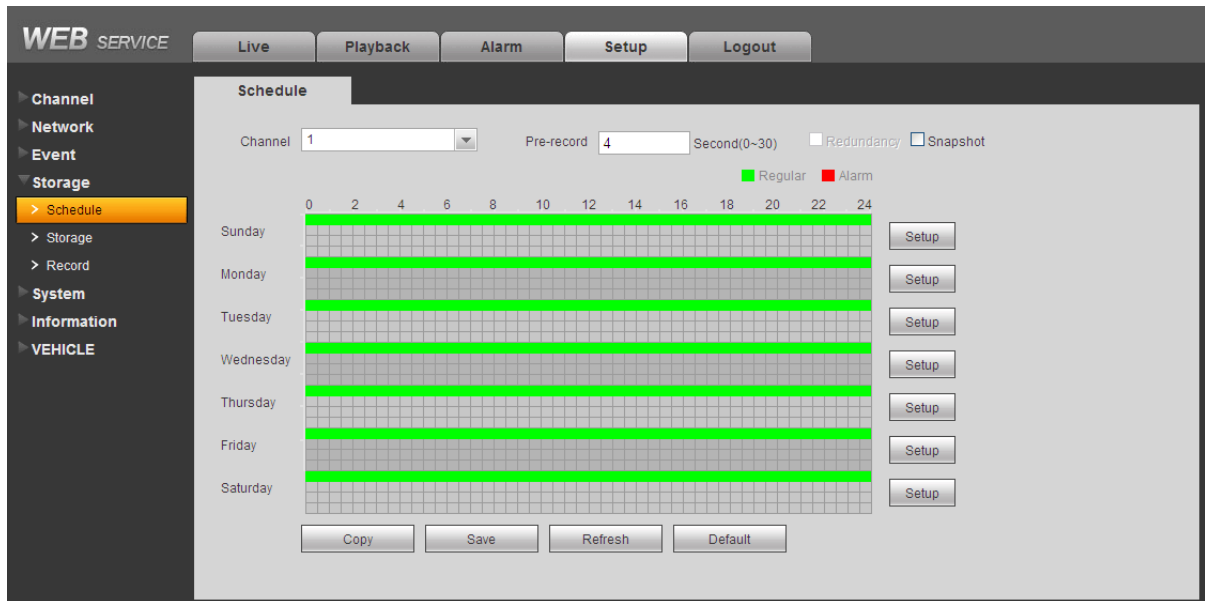

Figure 5-37

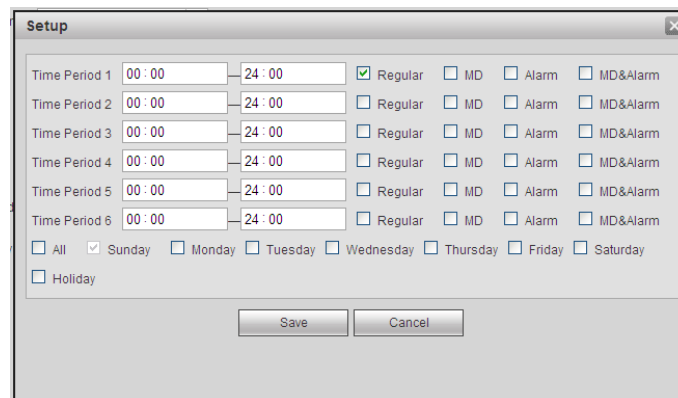

Figure 5-38

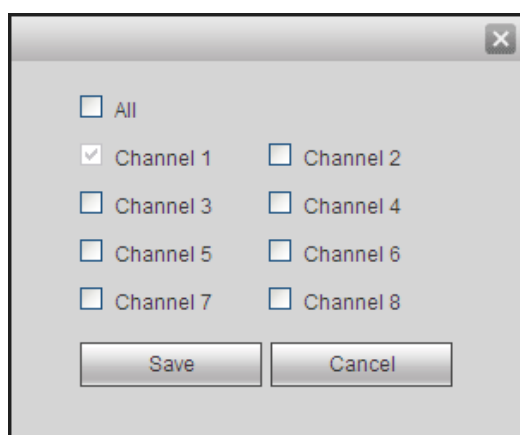

Figure 5-39

Please refer to the following sheet for detailed information.

Parameter	Function
Channel	Please select a channel from the dropdown list.
Pre-record	Please input pre-record time here. The value ranges from 0 to 30.
Redundancy	Check the box here to enable redundancy function. Please note this function is null if there is only one HDD.
Snapshot	Check the box here to enable snapshot function.
Holiday	Check the box here to enable holiday function.
Setup (Sunday to Saturday)	Click the Setup button, you can set record period. See Figure 5-38. There are six periods in one day. If you do not check the date at the bottom of the interface, current setup is for today only. Please click Save button and then exit.
Setup (Holiday)	Click the Setup button, you can set record period. See Figure 5-38. There are six periods in one day. If you check Holiday box, current channel shall record as your holiday setup here.
Copy	Copy function allows you to copy one channel setup to another. After setting in channel, click Copy button, you can go to interface Figure 5-39. You can see current channel name is grey such as channel 1. Now you can select the channel you want to paste such as channel 2. If you want to save current setup of channel 1 to all channels, you can click the first box "ALL". Click the OK button to save current copy setup. Click the OK button in the Encode interface, the copy function succeeded.

5.8.4.2 Storage

5.8.4.2.1 Local Storage

The local interface is shown as in Figure 5-40. Here you can see storage device information. You can also operate the read-only, write-only, hot swap and format operation.

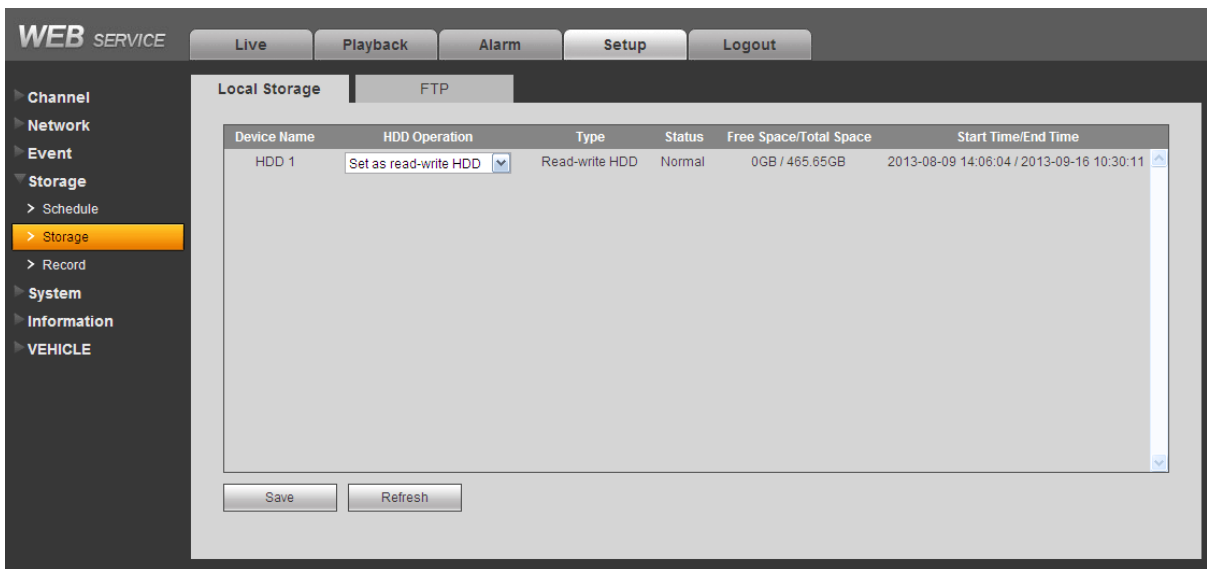

Figure 5-40

5.8.4.2.2 FTP

The FTP interface is shown as in Figure 5-41.

The FTP function is on if you check the Enable box here.

When network is offline or malfunction, system can save record or picture to HDD.

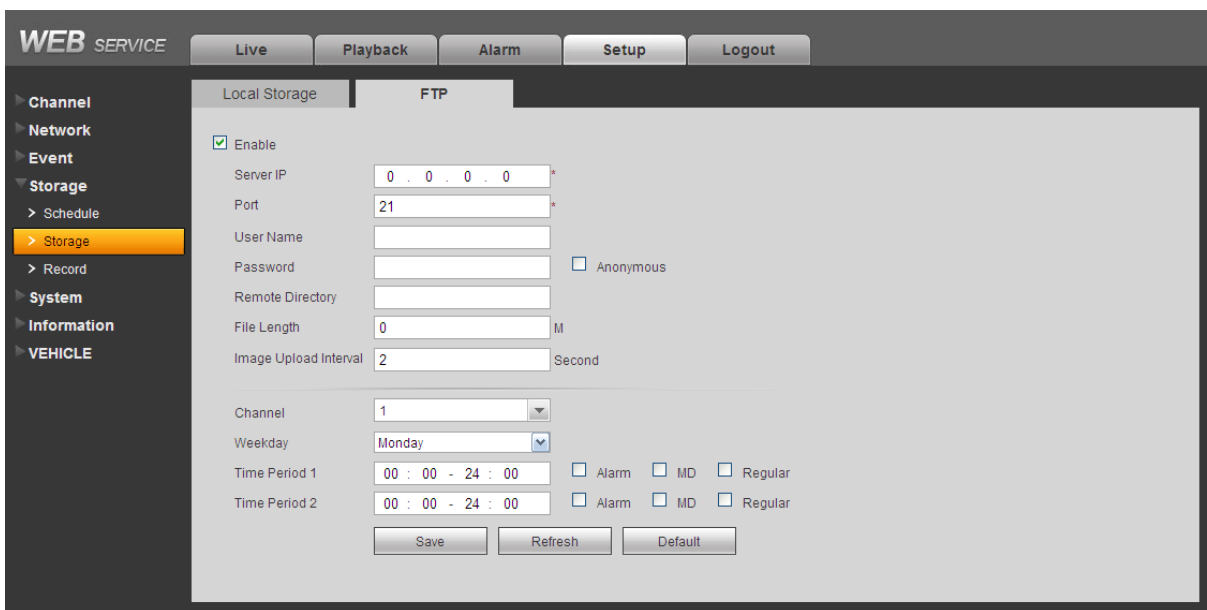

Figure 5-41

5.8.4.3 Record control

The record control interface is shown as in Figure 5-42.

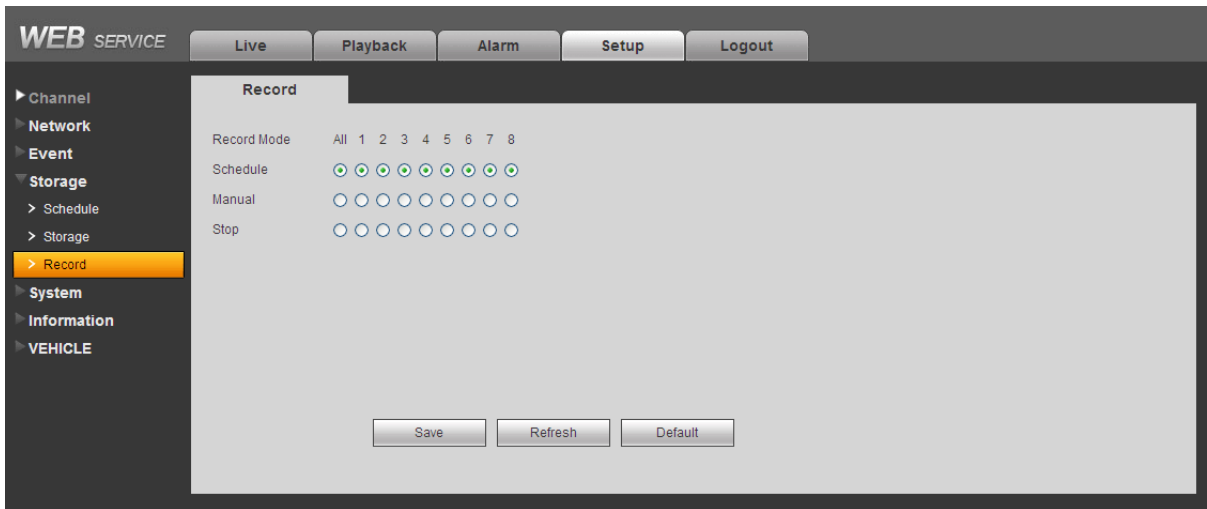

Figure 5-42

Please refer to the following sheet for detailed information.

Parameter	Function
Channel	Here you can view channel number. The number displayed here is the max channel amount of your device.
Status	There are three statuses: schedule, manual and stop.
Schedule	System enables auto record function as you set in record schedule setup (general and alarm).
Manual	It has the highest priority. Enable corresponding channel to record no matter what period applied in the record setup.
Stop	Stop current channel record no matter what period applied in the record setup.
Start all/ stop all	Check the corresponding All button, you can enable or disable all channels record.

5.8.5 System

5.8.5.1 General

The general interface includes General, date/time and holiday setup.

5.8.5.1.1 General

The general interface is shown as in Figure 5-43.

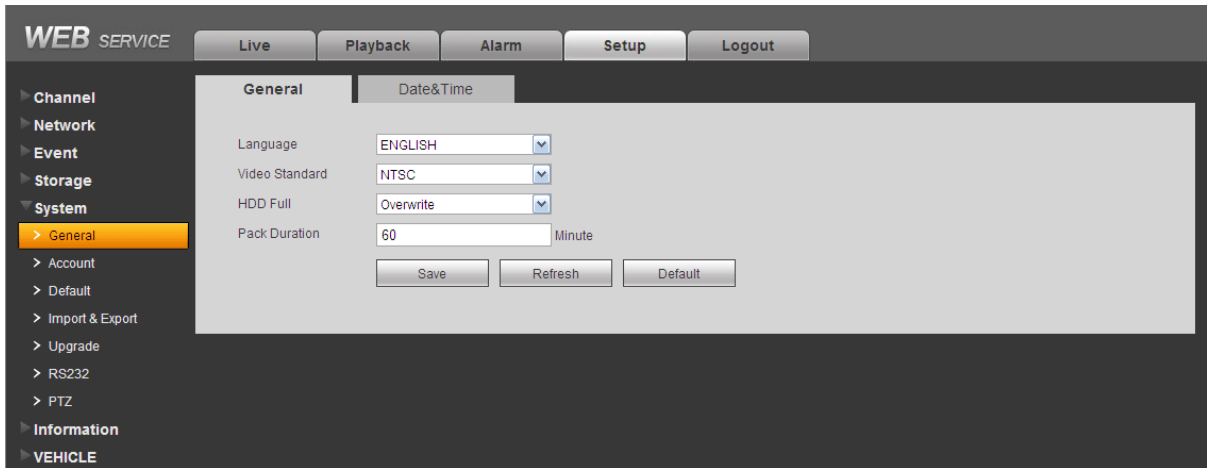

Figure 5-43

Please refer to the following sheet for detailed information.

Parameter	Function
Device ID	It is to set device name.
Device No.	It is device channel number.
Language	You can select the language from the dropdown list. Please note the device needs to reboot to get the modification activated.
Video Standard	This is to display video standard such as PAL.
HDD full	Here is for you to select working mode when hard disk is full. There are two options: stop recording or rewrite. If current working HDD is overwritten or the current HDD is full while the next HDD is no empty, then system stops recording, If the current HDD is full and then next HDD is not empty, then system overwrites the previous files.
Pack duration	Here is for you to specify record duration. The value ranges from 1 to 120 minutes. Default value is 60 minutes.

5.8.5.1.2 Date and time

The date and time interface is shown as in Figure 5-44

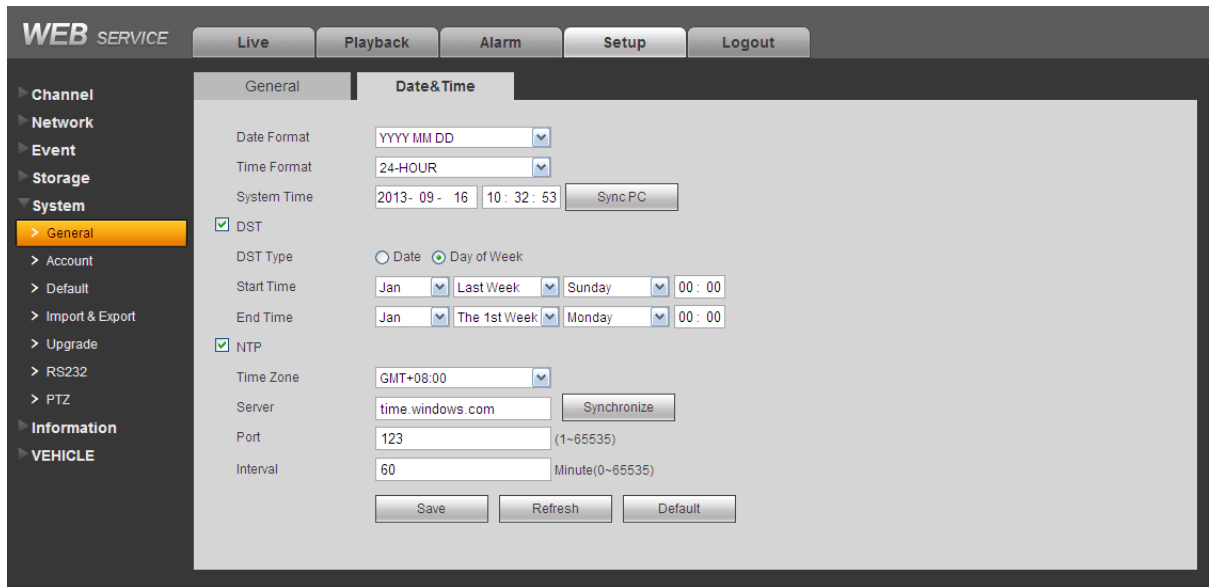

Figure 5-44

Please refer to the following sheet for detailed information.

Parameter	Function
Date format	Here you can select date format from the dropdown list.
Time Format	There are two options: 24-H and 12-H.
Time zone	The time zone of the device.
System time	It is to set system time. It becomes valid after you set.
Sync PC	You can click this button to save the system time as your PC current time.
DST	Here you can set day night save time begin time and end time. You can set according to the date format or according to the week format.
NTP	You can check the box to enable NTP function.
NTP server	You can set the time server address.
Port	It is to set the time server port.
Interval	It is to set the sync periods between the device and the time server.

5.8.5.2 Account

Note:

- For the character in the following user name or the user group name, system max supports 6-digits. The space in the front or at the end of the string is null. The valid string includes: character, number, and underline.
- The user amount is 20 and the group amount is 8 when the device is shipped out of the factory. The factory default setup includes two levels: user and admin. You can set the corresponding group and then set the rights for the respective user in the specified groups.

- User management adopts group/user modes. The user name and the group name shall be unique. One user shall be included in only one group.

5.8.5.2.1 User name

In this interface you can add/remove user and modify user name. See Figure 5-45.

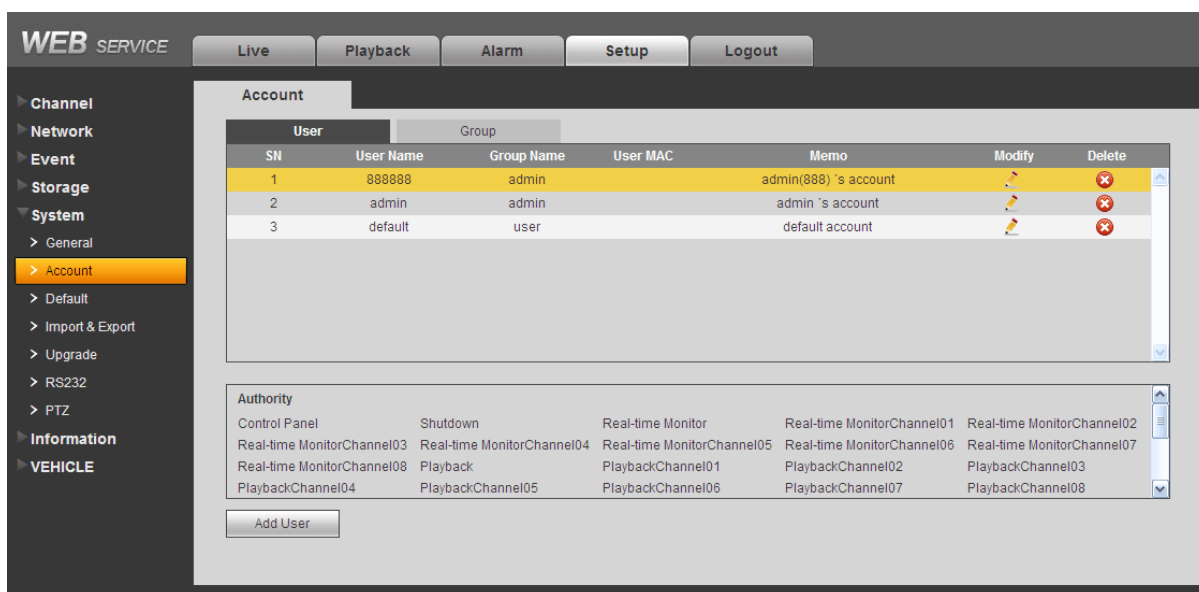

Figure 5-45

Add user: It is to add a name to group and set the user rights. See Figure 5-46.

There are three default administrator users: admin/888888 and hidden user “default”.

Hidden user “default” is for system interior use only and can not be deleted. When there is no login user, hidden user “default” automatically login. You can set some rights such as monitor for this user so that you can view some channel view without login.

Here you can input the user name and password and then select one group for current user.

Please note the user rights shall not exceed the group right setup.

For convenient setup, please make sure the general user has the lower rights setup than the admin.

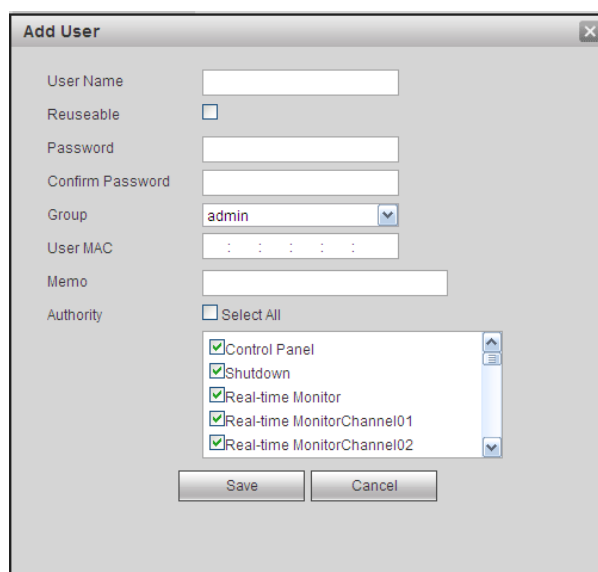

Figure 5-46

Modify user

It is to modify the user property, belonging group, password and rights. See Figure 5-47.

Modify password

It is to modify the user password. You need to input the old password and then input the new password twice to confirm the new setup. Please click the OK button to save.

Please note, the password ranges from 1-digit to 6-digit. It shall include the number only. For the user of the account rights, he can modify the password of other users.

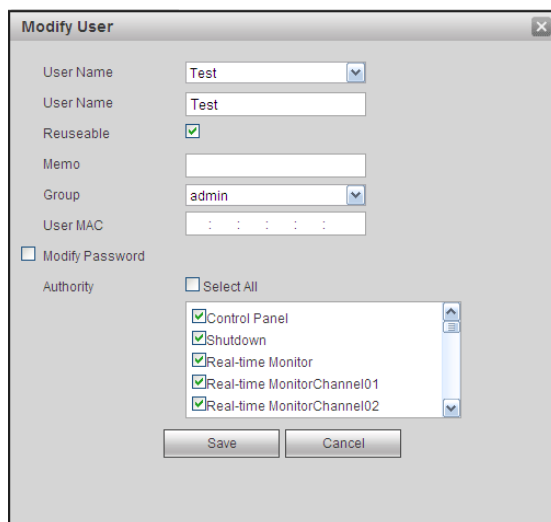
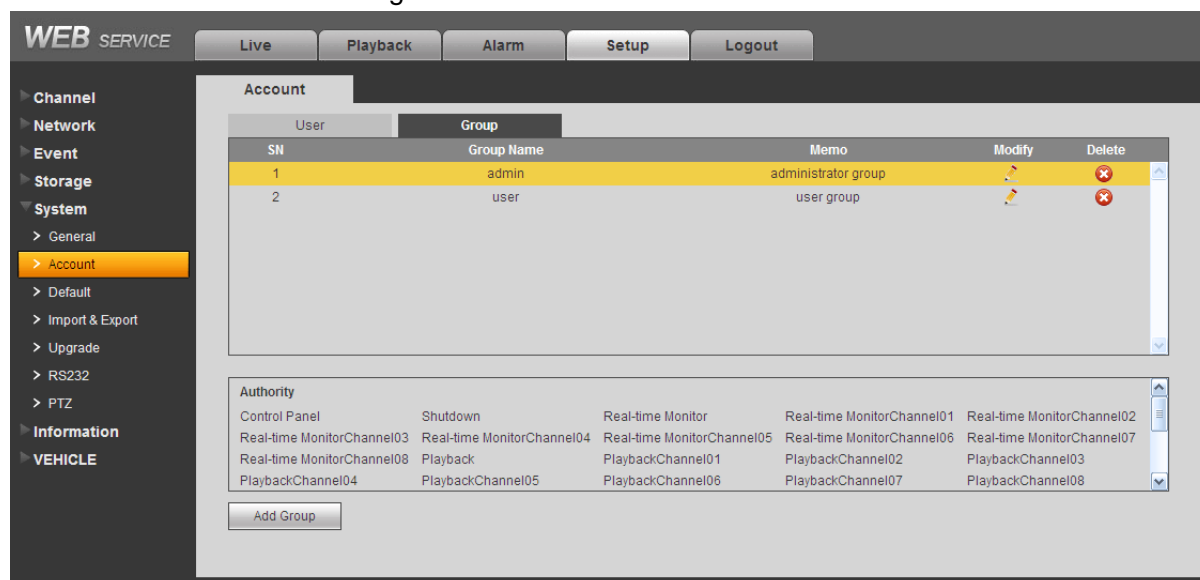

Figure 5-47

5.8.5.2.2 Group

The group management interface can add/remove group, modify group password and etc.

The interface is shown as in Figure 5-48.



SN	Group Name	Memo	Modify	Delete
1	admin	administrator group		
2	user	user group		

Authority

<input checked="" type="checkbox"/> Control Panel	<input checked="" type="checkbox"/> Shutdown	<input checked="" type="checkbox"/> Real-time Monitor	<input checked="" type="checkbox"/> Real-time MonitorChannel01	<input checked="" type="checkbox"/> Real-time MonitorChannel02
<input checked="" type="checkbox"/> Real-time MonitorChannel03	<input checked="" type="checkbox"/> Real-time MonitorChannel04	<input checked="" type="checkbox"/> Real-time MonitorChannel05	<input checked="" type="checkbox"/> Real-time MonitorChannel06	<input checked="" type="checkbox"/> Real-time MonitorChannel07
<input checked="" type="checkbox"/> Real-time MonitorChannel08	<input checked="" type="checkbox"/> Playback	<input checked="" type="checkbox"/> PlaybackChannel01	<input checked="" type="checkbox"/> PlaybackChannel02	<input checked="" type="checkbox"/> PlaybackChannel03
<input checked="" type="checkbox"/> PlaybackChannel04	<input checked="" type="checkbox"/> PlaybackChannel05	<input checked="" type="checkbox"/> PlaybackChannel06	<input checked="" type="checkbox"/> PlaybackChannel07	<input checked="" type="checkbox"/> PlaybackChannel08

Add Group

Figure 5-48

Add group: It is to add group and set its corresponding rights. See Figure 5-49.

Please input the group name and then check the box to select the corresponding rights. It includes: shutdown/reboot device, live view, record control, PTZ control and etc.

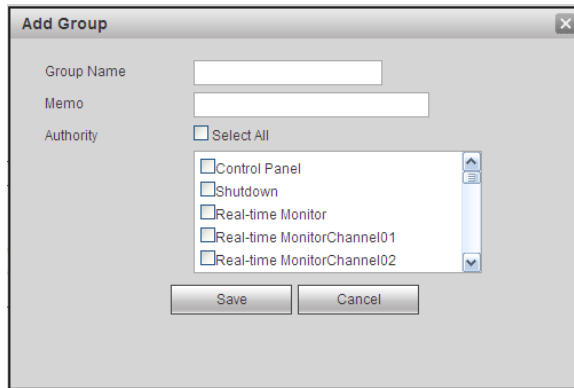

Figure 5-49

Modify group

Click the modify group button, you can see an interface is shown as in Figure 5-50. Here you can modify group information such as remarks and rights.

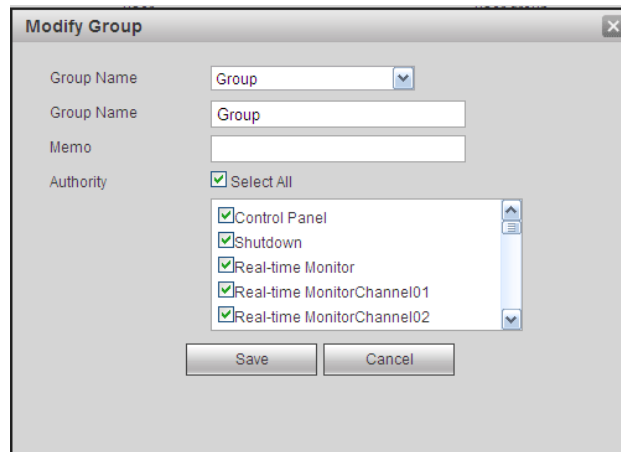

Figure 5-50

5.8.5.3 Default

The default setup interface is shown as in Figure 5-51.

Here you can select Channel/Network/Event/Storage/System. Or you can check the All box to select all items.

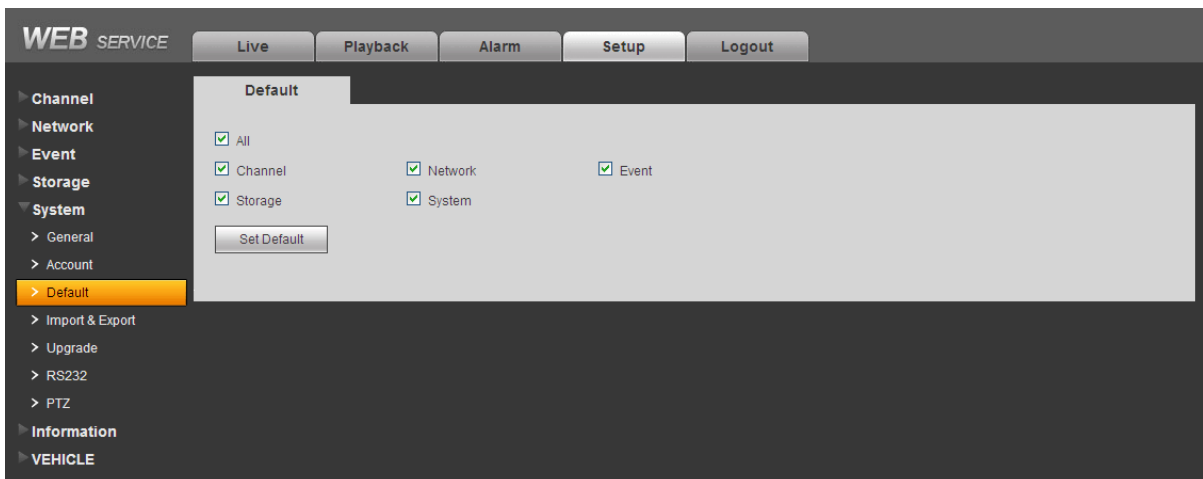

Figure 5-51

5.8.5.4 Import/Export

The interface is shown as in Figure 5-52.

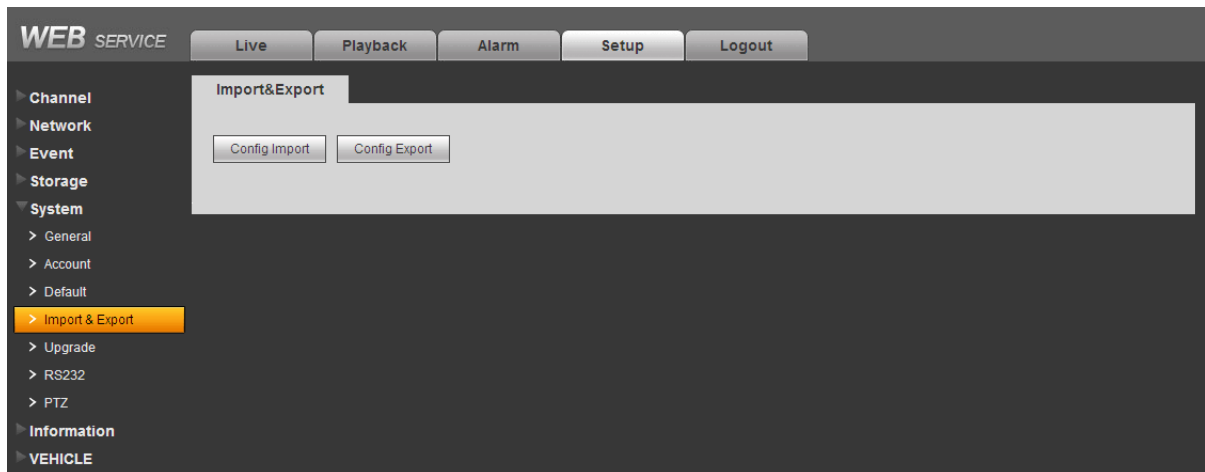

Figure 5-52

Please refer to the following sheet for detailed information.

Parameter	Function
Import	It is to import the local setup files to the system.
Export	It is to export the corresponding WEB setup to your local PC.

5.8.5.5 Upgrade

The upgrade interface is shown as in Figure 5-53.

Please select the upgrade file and then click the update button to begin update. Please note the file name shall be as *.bin. During the upgrade process, do not unplug the power cable, network cable, or shutdown the device.

Important

Improper upgrade program may result in device malfunction!

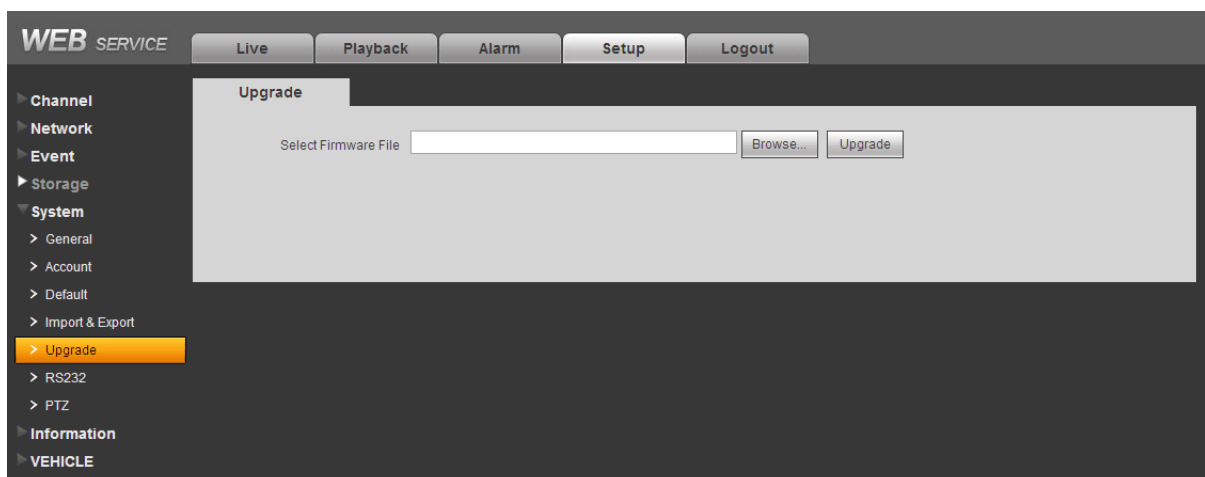

Figure 5-53

5.8.5.6 RS232

The RS232 interface is shown as in Figure 5-54.

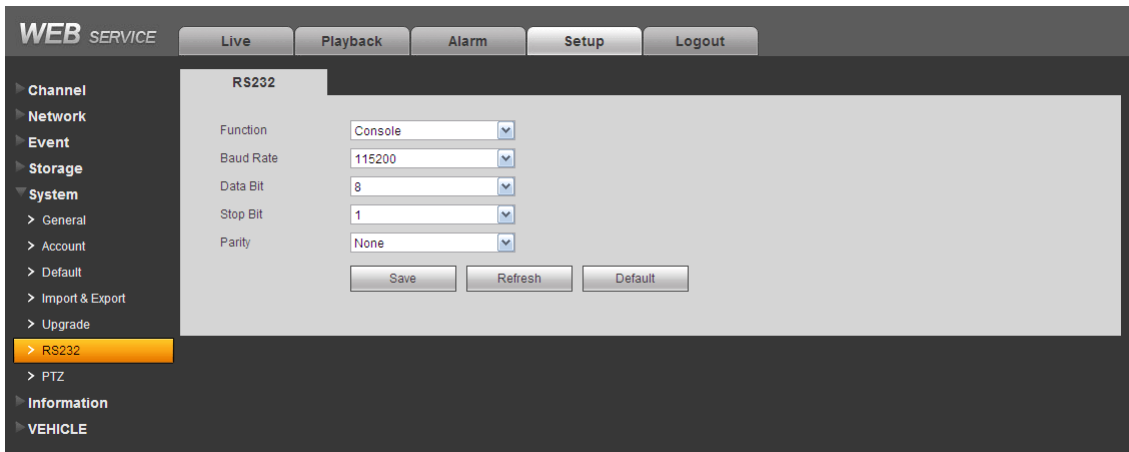

Figure 5-54

Please refer to the following sheet for detailed information.

Parameter	Function
Function	Select the corresponding COM control protocol. Default setup is console.
Baud Rate	Select the baud rate. Default setup is 115200.
Data Bit	The value ranges from 5 to 8. Default setup is 8.
Stop bit	There are two options: 1/2. Default setup is 1.
Parity	There are five options: none/odd/even/space/mark. Default setup is none.

5.8.5.7 PTZ

The PTZ interface is shown as in Figure 5-55.

Before setup, please check the following connections are right:

- PTZ and decoder connection is right. Decoder address setup is right.
- Decoder A (B) line connects with DVR A (B) line.

Click Save button after you complete setup, you can go back to the monitor interface to control speed dome.

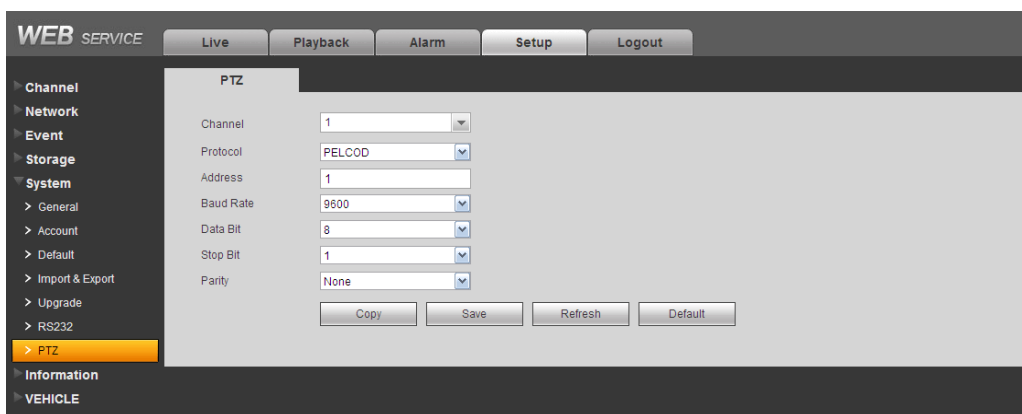

Figure 5-55

Please refer to the following sheet for detailed information.

Parameter	Function
Channel	Select speed dome connected channel.
Protocol	Select the corresponding dome protocol such as PELCOD.
Address	Set corresponding dome address. Default value is 1. Please note your setup here shall comply with your dome address; otherwise you can not control the speed dome.
Baud Rate	Select the dome baud rate. Default setup is 9600.
Data Bit	Default setup is 8. Please set according to the speed dome dial switch setup.
Stop bit	Default setup is 1. Please set according to the speed dome dial switch setup.
Parity	Default setup is none. Please set according to the speed dome dial switch setup.

5.8.6 Information

5.8.6.1 Version

The version interface is shown as in Figure 5-56.

Here you can view system hardware features, software version, release date and etc. Please note the following information is for reference only.



Figure 5-56

5.8.6.2 Log

Here you can view system log. See Figure 5-57.

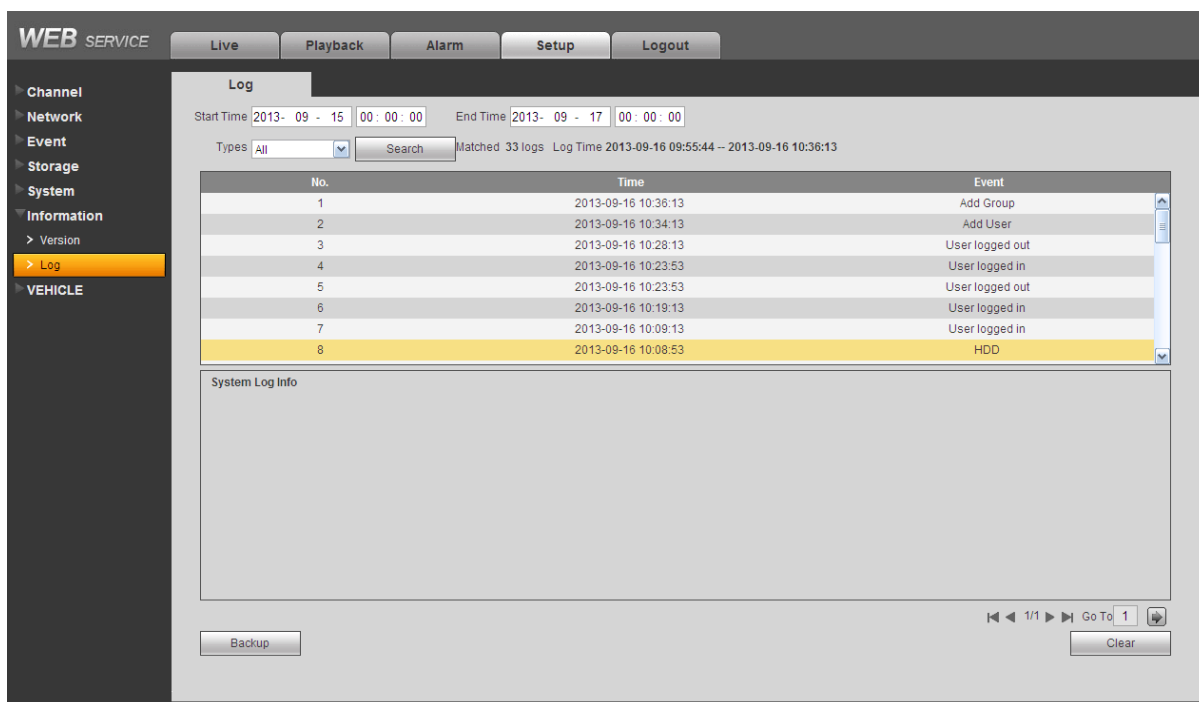

Figure 5-57

Please refer to the following sheet for log parameter information.

Parameter	Function
Type	Log types include: system operation, configuration operation, data operation, event operation, record operation, user management, log clear.
Start time	Set the start time of the requested log.
End time	Set the end time of the requested log.
Search	You can select log type from the drop down list and then click search button to view the list. You can click the stop button to terminate current search operation.
Detailed information	You can select one item to view the detailed information.
Clear	You can click this button to delete all displayed log files. Please note system does not support clear by type.
Backup	You can click this button to backup log files to current PC.

5.8.7 Vehicle

5.8.7.1 Vehicle

The vehicle setup interface is shown as in Figure 5-58. Here you can set device auto start and shut down time and plate information.

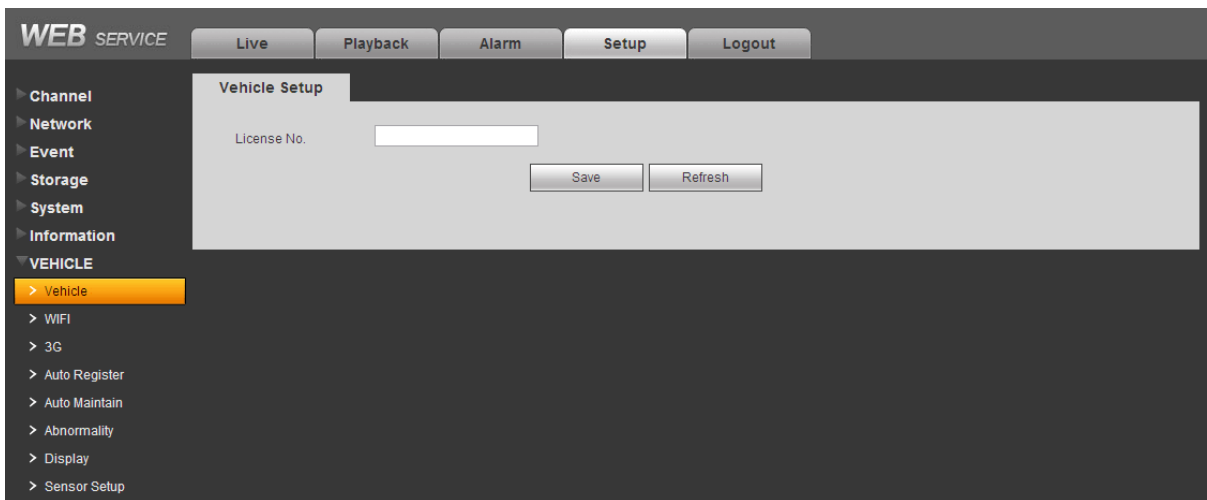

Figure 5-58

5.8.7.2 WIFI

Please note this function is for the device of WIFI module.

The WIFI interface is shown as in Figure 5-59.

Please refer to chapter 4.9.2 for detailed setup information.

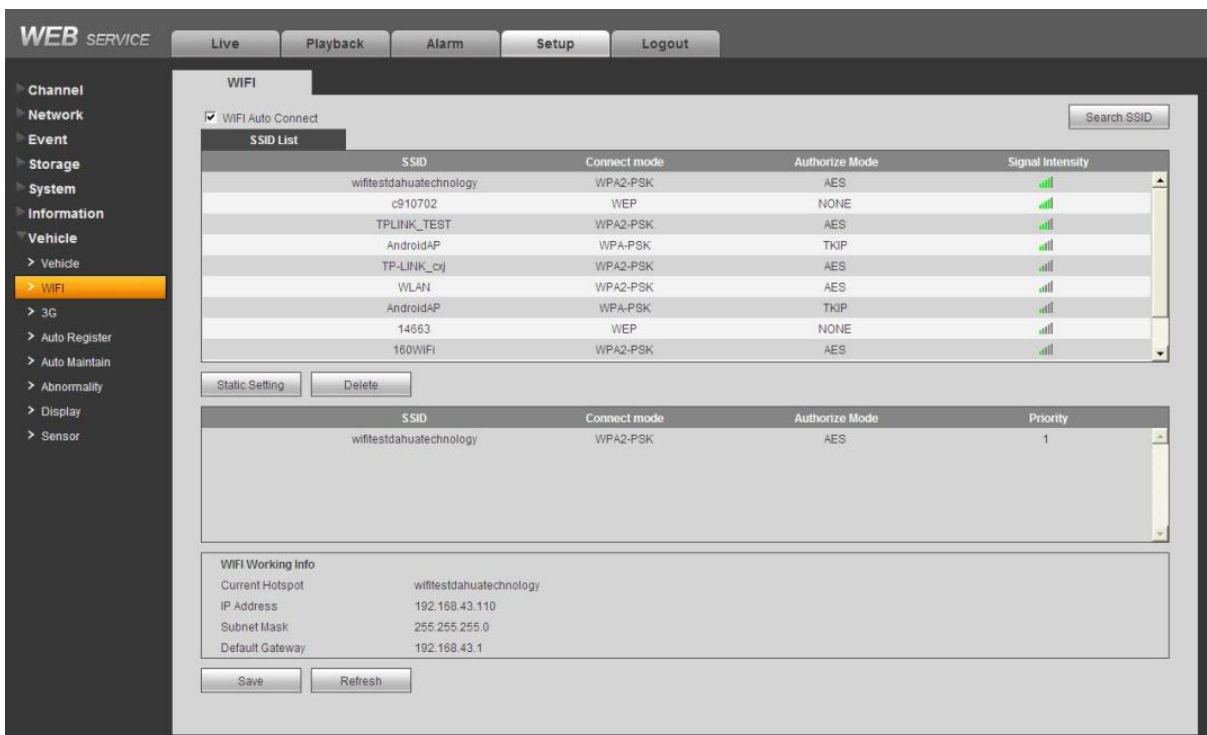

Figure 5-59

Please check the box to enable WIFI function and then click the Search SSID button. Now you can view all the wireless network information in the following list. Double click a name to connect to it. Click Refresh button, you can view latest connection status.

Click Static setting button, you can go to WIFI setup interface. Here you can input SSID (wireless network name) and verification type such as OPEN, WEP, WPA-PSK, and WPA2-PSK.

5.8.7.3 3G

Please refer to chapter 4.9.1 for detailed setup information.

5.8.7.3.1 CDMA/GPRS

The CDMA/GPRS interface is shown as in Figure 5-60.

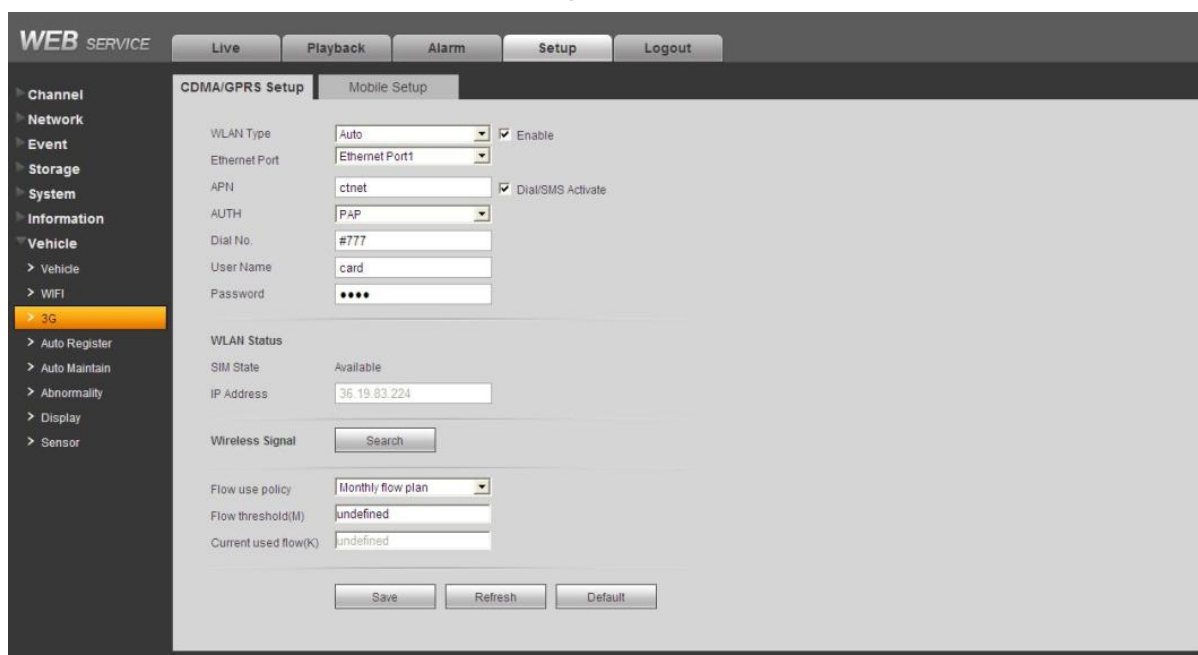

Figure 5-60

Please refer to the following sheet for detailed information.

Parameter	Function
WLAN type	Here you can select 3G network type to distinguish the 3G module from different ISP. The types include WCDMA, CDMA1x and etc.
APN/.	Here is the important parameter of PPP.
Authorization	It includes PAP,CHAP,NO_AUTH.
Dial No	The network dial number you got from your ISP.
User Name	The user name you login the 3G network.
Password	The password you login the 3G network.
SIM State	Display SIM card status.
IP Address	Display automatically got IP address after 3G online.
Wireless Signal	Display signal intensity.
Flow Use Policy	Select flow policy.
Flow Threshold(M)	Set flow threshold.
Current Used Flow(K)	Currently used flow.

5.8.7.3.2 Mobile

The mobile setup interface is shown as in Figure 5-61.

Here you can activate or turn off the 3G connected phone or mobile phone, or the phone you set to get alarm message.

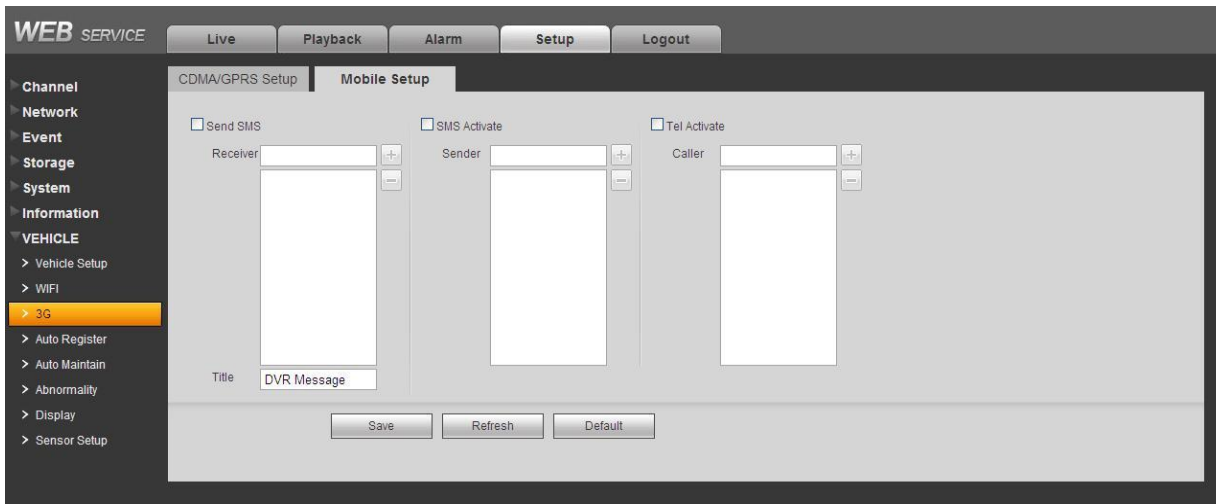

Figure 5-61

5.8.7.4 Auto Register

The auto register interface is shown as in Figure 5-62. After the device connects to the network, it can send out auto register query to the specified server.

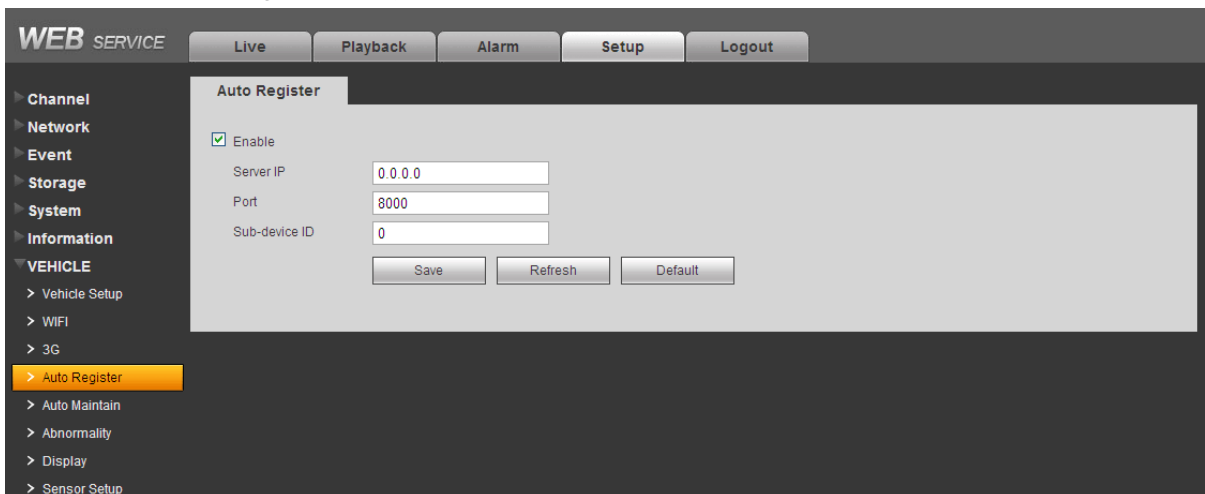

Figure 5-62

Please refer to the following sheet for detailed information.

Parameter	Function
Server IP	DSS server IP address.
Port	DSS server port value.
Sub-device ID	The device ID set from the DSS.

5.8.7.5 Auto Maintenance

The auto maintenance interface is shown as in Figure 5-63.

Here you can select auto reboot and auto delete old files interval from the dropdown list.

If you want to use the auto delete old files function, you need to set the file period.

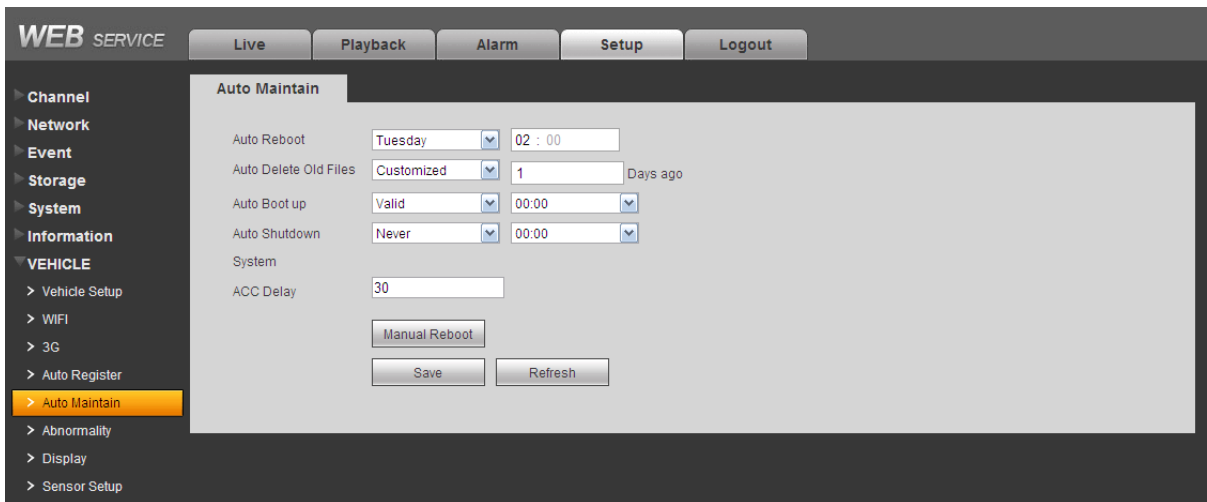

Figure 5-63

5.8.7.6 Abnormality

It includes six statuses: No disk, disk error, disk no space, battery low, temperature high. See Figure 5-64 through Figure 5-68.

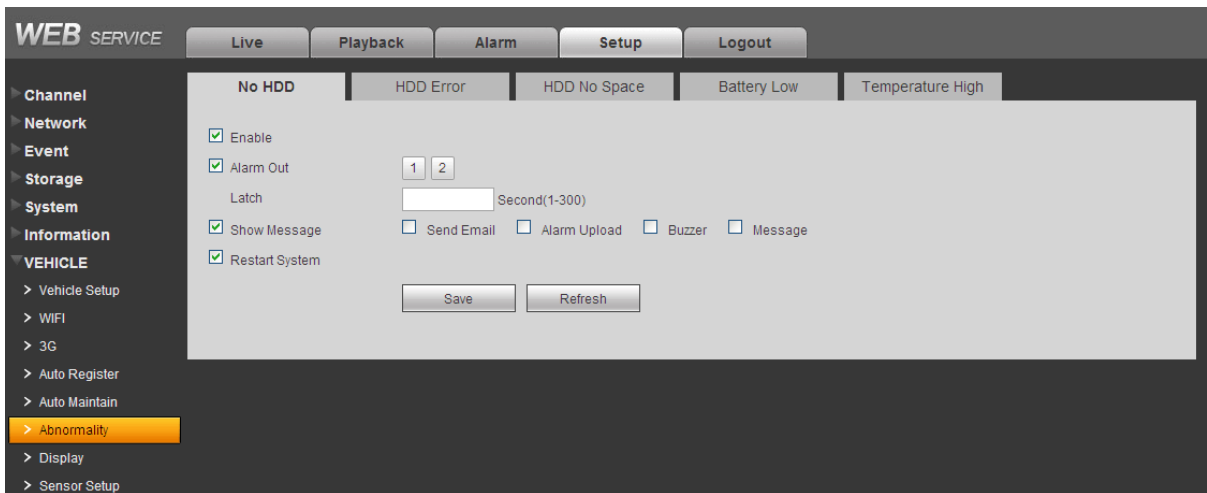

Figure 5-64

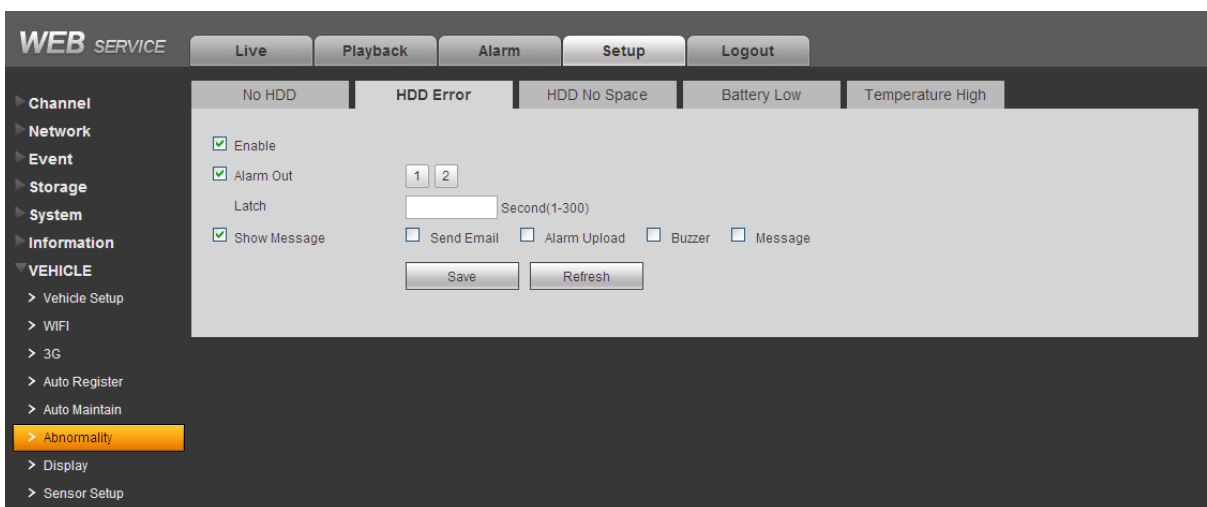

Figure 5-65

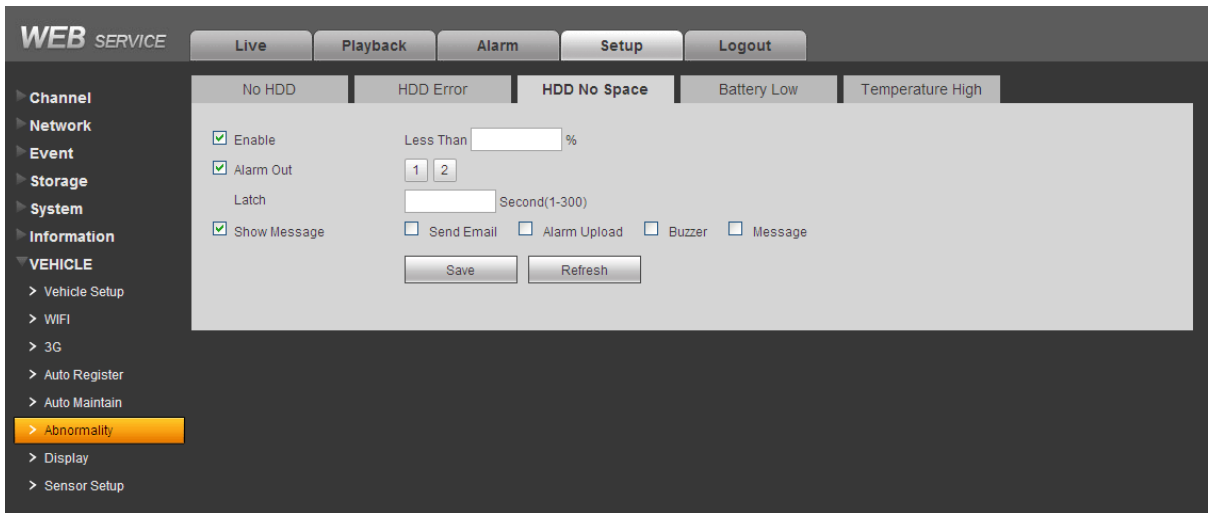

Figure 5-66

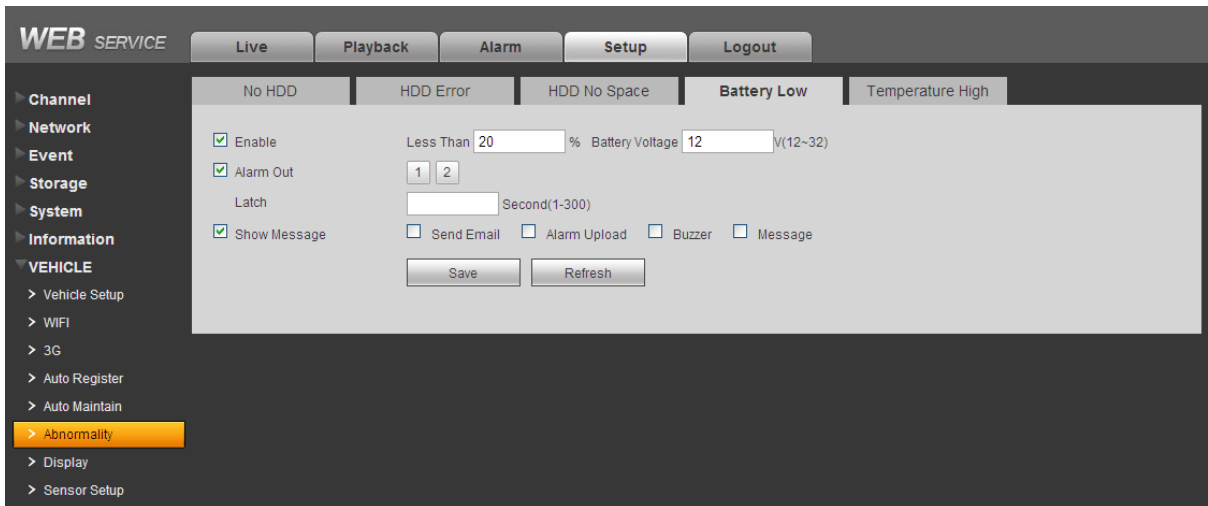

Figure 5-67

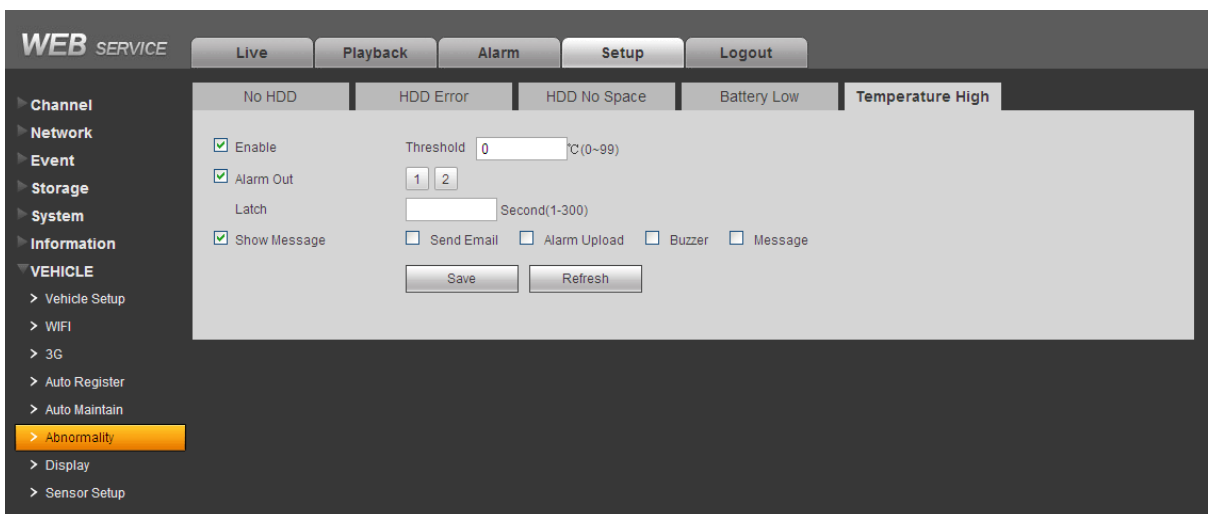

Figure 5-68

Please refer to the following sheet for detailed information.

Parameter	Function
Event Type	The abnormal events include: No disk, disk error, disk no space, battery low, temperature high. You can set one or more items here.
Enable	Check the box here to enable selected function.
Alarm Out	Please select corresponding alarm output channel when an alarm occurs. You need to check the box to enable this function.
Latch	The alarm output can delay for the specified time after an alarm stops. The value ranges from 1s to 300s.
Show message	System can pop up a message to alarm you in the local host screen if you enabled this function.
Alarm upload	System can upload the alarm signal to the centre (Including alarm centre).
Send Email	If you enabled this function, System can send out an email to alert you when an alarm occurs.
Buzzer	Check the box here to enable this function. The buzzer beeps when an alarm occurs.

5.8.7.7 Display

Display interface includes GUI, and TV adjust.

5.8.7.7.1 GUI

Here you can set background color and transparency level. See Figure 5-69.

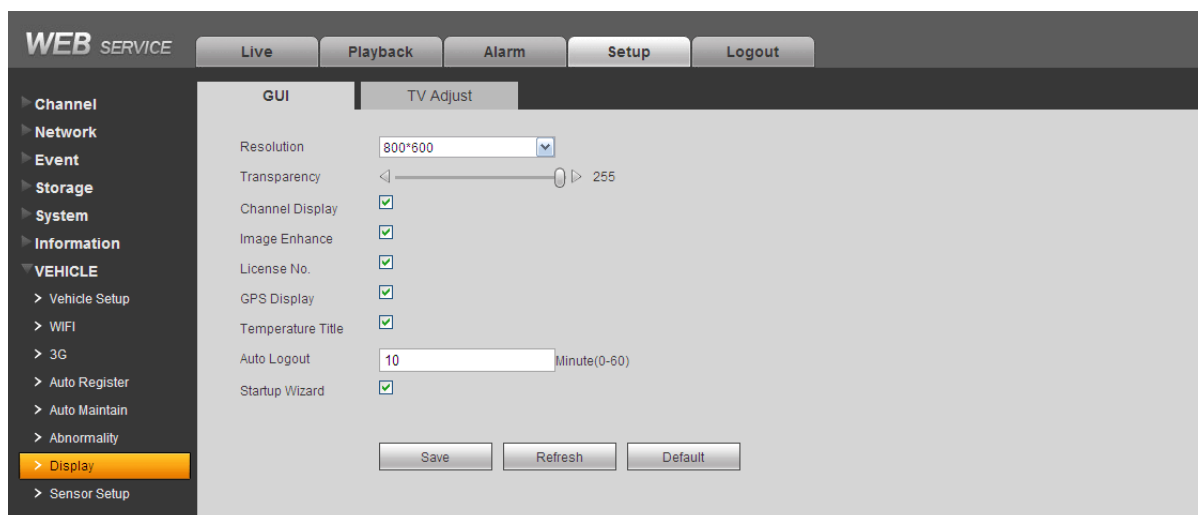

Figure 5-69

Please refer to the following sheet for detailed information.

Parameter	Function
Resolution	There are five options: 1920×1080, 1280×1024, 1280×720, 1024×768, 800×600(Default). Please note the system needs to reboot to activate current setup.
Transparency	Here is for you to adjust transparency. The value ranges from 128 to 255.

Time title/channel title	Check the box here, you can view system time and channel number on the monitor video.
Image enhance	Check the box; you can optimize the margin of the preview video.
Auto logout	Here is for you to set auto logout interval once login user remains inactive for a specified time.
Startup wizard	Check the box here, system goes to the startup wizard when the device boots up the next time. Otherwise, it goes to the system login interface directly.
Navigation bar	Check the box here, system displays the navigation bar on the interface.

5.8.7.7.2 TV Adjust

It is to set TV output region. See Figure 5-70.

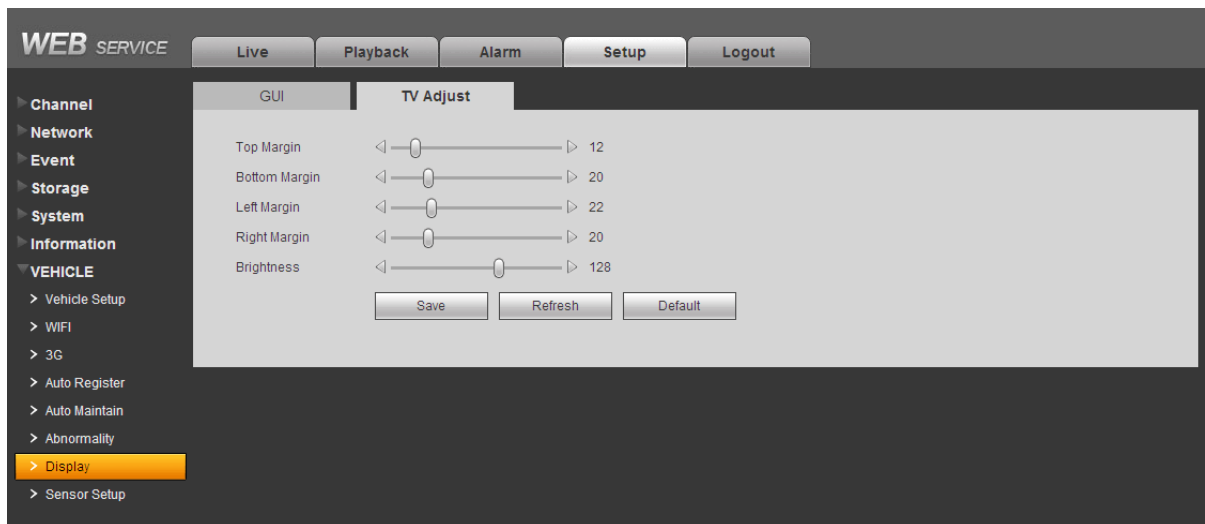

Figure 5-70

5.8.7.8 Sensor

It is to set sensor information.

5.8.7.8.1 Speed

Please refer to your vehicle user's manual to set speed information. See Figure 5-71

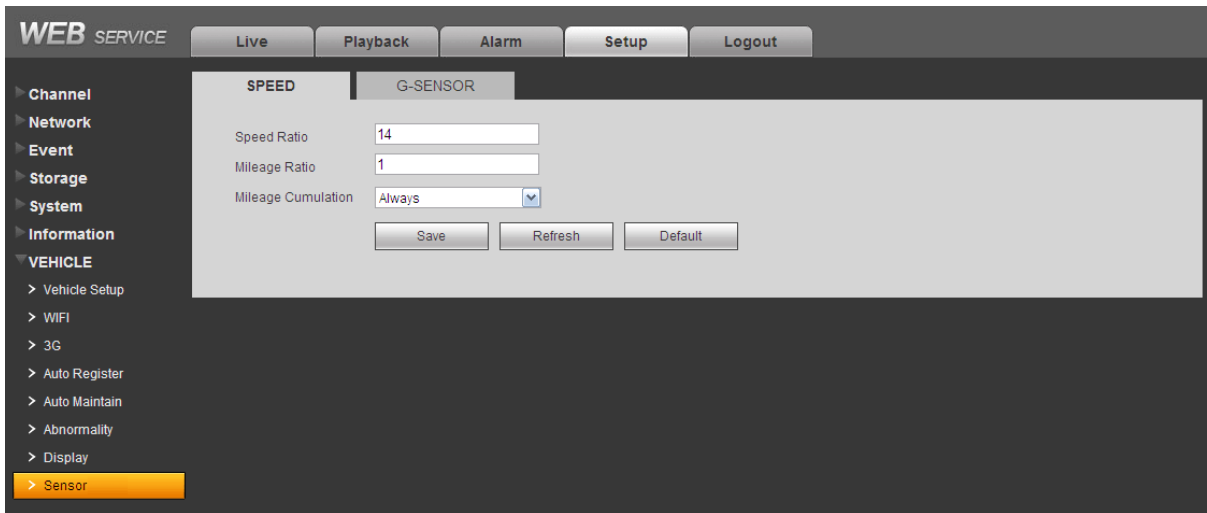

Figure 5-71

5.8.7.8.2 G-Sensor

Please set according to your device installation direction. See Figure 5-72

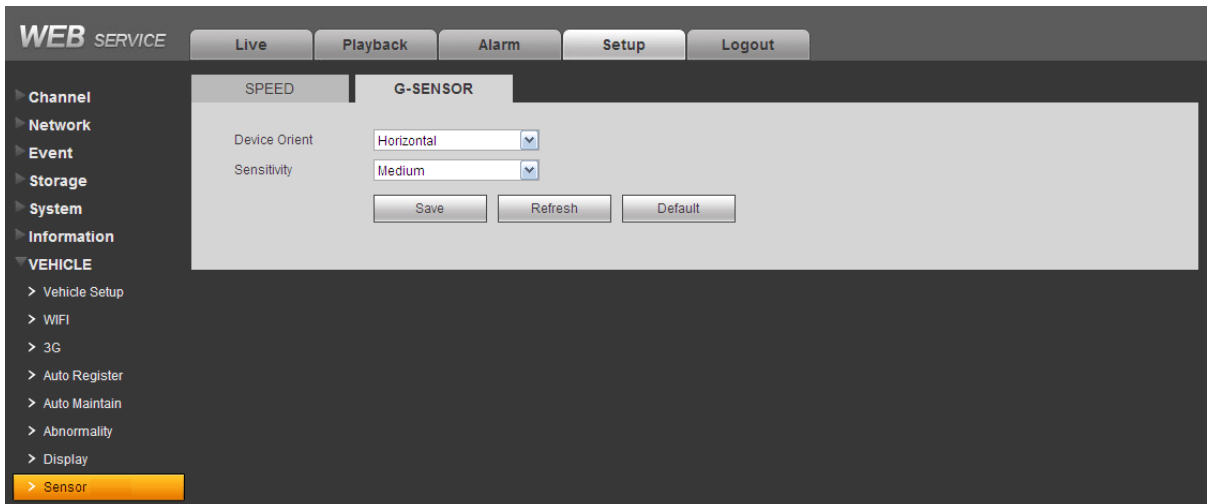

Figure 5-72

5.9 Playback

Click Playback button, you can see an interface is shown as in Figure 5-73.

Please set record type, record date, window display mode and channel name.

You can click the date on the right pane to select the date. The green highlighted date is system current date and the blue highlighted date means it has record files.

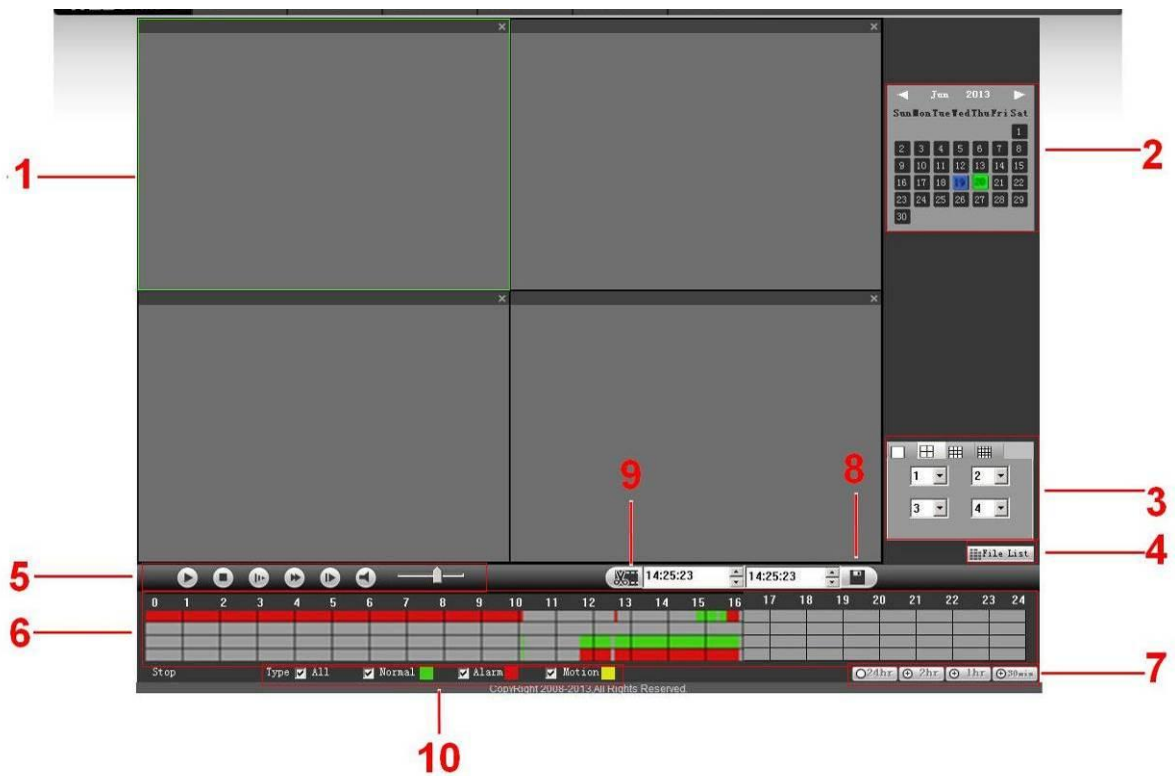













Figure 5-73

Please refer to the following sheet for detailed information.

SN	Function	Description
1	Display window	Click  to switch window amount. During the playback process, double click a window to zoom in.
2	Calendar	The blue highlighted date means there is picture or file. Otherwise, there is no picture or file. In any play mode, click the date you want to see, you can see the corresponding record file trace in the time bar.
3	Playback mode and channel selection pane.	Playback mode: 1/4/9/16-channel. The time bar will change once you modify the playback mode or the channel option.
4	File list switch button	<ul style="list-style-type: none"> ✦ Click it to view record list of current date. ✦ Input a time at the top of the interface, you can search record of accurate time.  ✦ You can view all record files after current search date. Use the ▲/▼ or the mouse to view the file. Select one item, and then double click the mouse or click the ENTER button to playback. ✦ File type: R—regular record; A—external alarm record; ✦ Download: Save file to current PC. ✦ Download more: Set download file(s). <p>Watermark: It is to check the file has been tampered with or not via the watermark verification.</p>

5	Playback control pane.	 Play/Pause There are three ways for you to begin playback. <ul style="list-style-type: none"> ● The play button ● Double click the valid period of the time bar. ● Double click the item in the file list. In slow play mode, click it to switch between play/pause. <hr/>  Stop <hr/>  <p>In playback mode, click it to play the next or the previous section. You can click continuously when you are watching the files from the same channel.</p> <p>In normal play mode, when you pause current play, you can click ◀ and ▶ to begin frame by frame playback.</p> <p>In frame by frame playback mode, click ▶/ to restore normal playback. (if you click pause button during normal playback process, you can click ▶ to begin frame by frame playback.)</p> <hr/>  Slow play In playback mode, click it to realize various slow play modes such as slow play 1, slow play 2, and etc. <hr/>  Fast forward In playback mode, click to realize various fast play modes such as fast play 1, fast play 2 and etc. <hr/>  <p>Support playback volume. Support mute function.</p>
6	Time bar	<ul style="list-style-type: none"> ● It is to display the record type and its period in current search criteria. ● In 4-window playback mode, there are corresponding four time bars. In other playback mode, there is only one time bar. ● Use the mouse to click one point of the color zone in the time bar, system begins playback. ● The time bar is beginning with 0 o'clock when you are setting the configuration. The time bar zooms in the period of the current playback time when you are playing the file. ● The green color stands for the regular record file. The red color stands for the external alarm record file.
7	Time bar unit	<ul style="list-style-type: none"> ● ●The option includes: 24H, 12H, 1H and 30M. The smaller the unit, the larger the zoom rate. You can accurately set the time in the time bar to playback the record. ● The time bar is beginning with 0 o'clock when you are setting the configuration. The time bar zooms in the period of the

		current playback time when you are playing the file.
8	Backup	 <p>Select the file(s) you want to backup from the file list. System max supports files from four channels. Then click the backup button, now you can see the backup menu. Click the start button to begin the backup operation.</p> <p>Check the file again you can cancel current selection.</p> <p>System max supports to display 32 files from one channel.</p>
9	Clip	 <p>It is to edit the file.</p> <p>Please play the file you want to edit and then click this button when you want to edit. You can see the corresponding slide bar in</p> <p>the time bar of the corresponding channel such as  and .</p> <p>You can adjust the slide bar or input the accurate time to set the file end time. Click this button again and then save current contents in a new file.</p>
10	Record type	<p>In any play mode, the time bar will change once you modify the search type.</p> <p>Right now system supports general, and alarm.</p>

Then please click file list button (Button 4 in Figure 5-73), you can see the corresponding files in the list. See Figure 5-74.

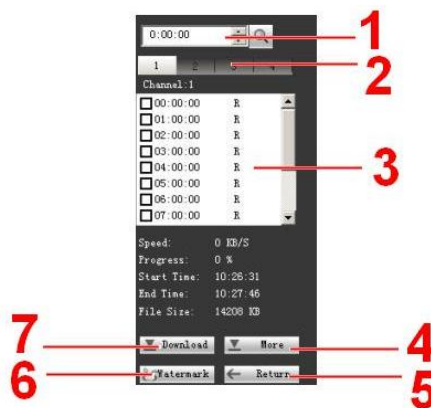

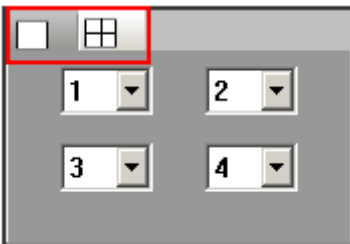



Figure 5-74

SN	Description
1	<p>Please select a date on the calendar pane and then input time here to search records of the specified time.</p> 

SN	Description
2	<p>Then you can select window mode and channel.</p> 
3	<p>System displays all records of current date by default. Click Enter button or double a record file you can begin playback. The record type includes: normal, and alarm.</p> 
4	<p>Click More button, you can search record files or picture. You can download by setting record channel, record type and record time.</p> <p>Click start back button on the remote backup interface, it allows you to backup the record or picture to your local USB storage media via the Web remotely. Click the search button; you can view the available storage device. Please select file(s) from the list and then Click Start backup button.</p> <p>You can go to chapter 5.8.1.2.6 to set download path.</p>
5	Return
6	User watermark function to check the record has been tampered with or not.
7	<p>Check the file(s) you want to backup (<input checked="" type="checkbox"/>) and then click Download to save on your local PC.</p> <p>Important System max supports select download files from 4-channels.</p>

Load more

It is for you to search record or picture. You can select record channel, record type and record time to download. See Figure 5-75.

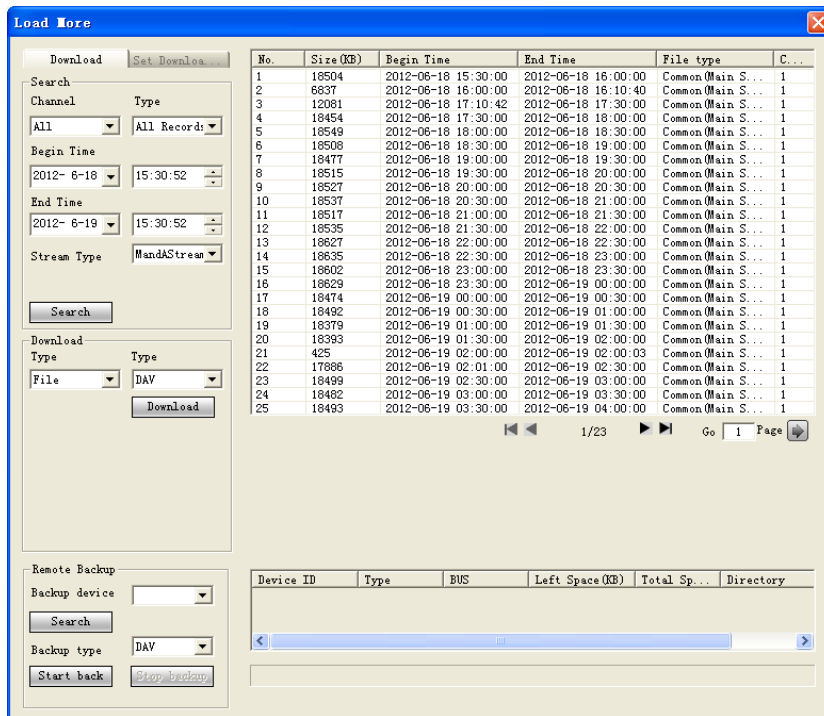

Figure 5-75

Remote backup

In Figure 5-75, there is a remote back pane at the left bottom of the pane. It allows you to backup the record or picture to your local USB storage media via the Web remotely. Click the search button; you can view the available storage device. See Figure 5-76. Please select file(s) from the list and then Click Start backup button. Please refer to chapter 5.8.1.2.6 to set device download path.

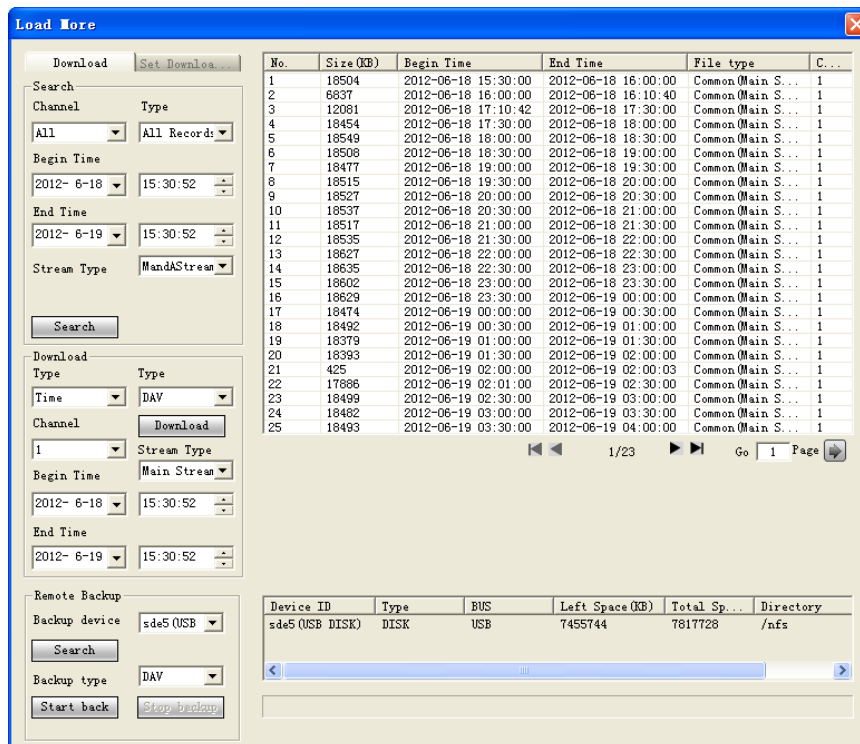

Figure 5-76

Now you can see system begins backup and the Stop backup button becomes valid. You can click it to terminate current operation.

At the bottom of the interface, there is a process bar for your reference.

5.10 Alarm

Click alarm function, you can see an interface is shown as Figure 5-77.

Here you can set device alarm type and alarm sound setup.

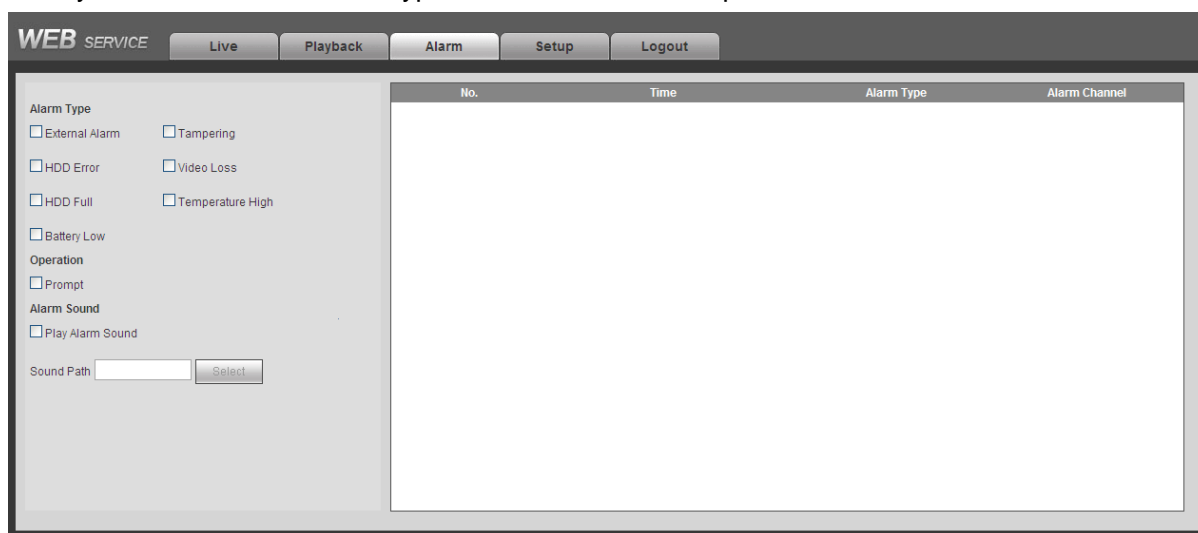

Figure 5-77

Please refer to the following sheet for detailed information.

Please make sure current device can upload the alarm.

Type	Parameter	Function
Alarm Type	Video loss	System alarms when video loss occurs.
	Camera masking(Tampering)	System alarms when camera is viciously masking.
	Disk full	System alarms when disk is full.
	Disk error	System alarms when disk error occurs.
	External alarm	Alarm input device sends out alarm.
	Temperature high	System alarms when temperature is high.
	Battery low	System alarms when battery voltage is low
Operation	Prompt	Check the box here, system can automatically pops up an alarm icon on the Alarm button in the main interface when there is an alarm.
Alarm Sound	Play alarm sound	System sends out alarm sound when an alarm occurs. You can specify as you wish.
	Sound path	Here you can specify alarm sound file.

5.11 Log out

Click log out button, system goes back to log in interface. See Figure 5-78.

You need to input user name and password to login again.

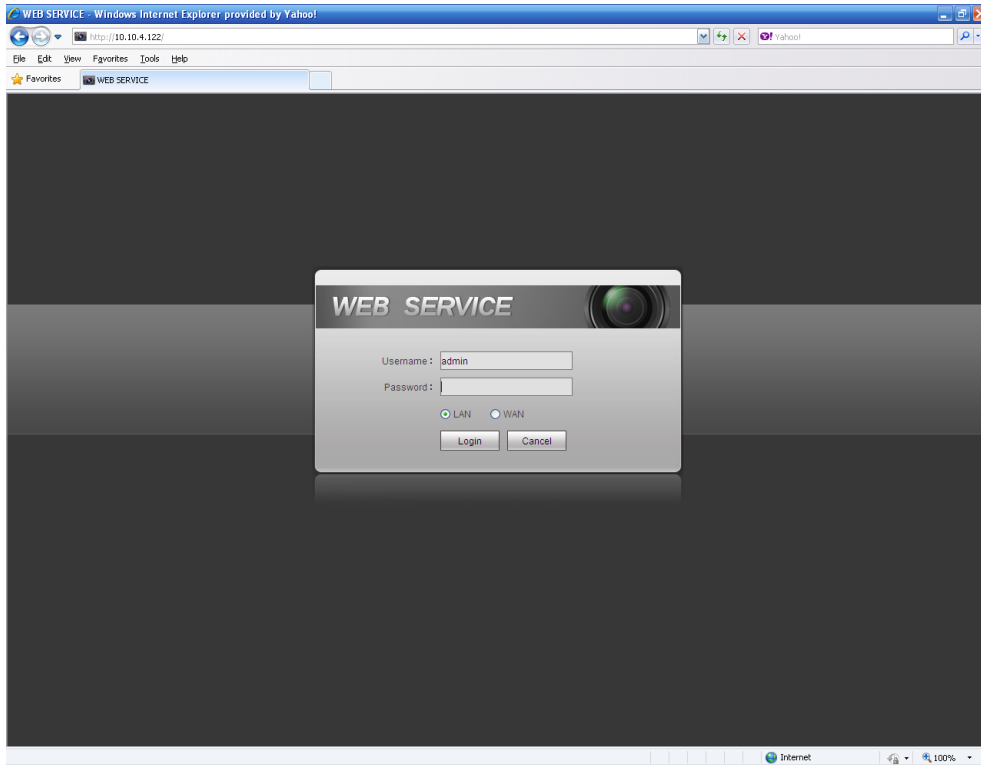

Figure 5-78

5.12 Un-install Web Control

You can use web un-install tool "uninstall web.bat" to un-install web control.

Please note, before you un-installation, please close all web pages, otherwise the un-installation might result in error.

6 Digital Surveillance System

Besides Web, you can use our Digital Surveillance Software (DSS) to login the device.
For detailed information, please refer to *DSS user's manual*.

7 FAQ

1. After the vehicle started, the DVR can not boot up properly.

There are following possibilities:

- Input power is not correct. It is too high or too low.
- Power connection is not correct.
- Power switch button is damaged.
- Program upgrade is wrong.
- HDD malfunction or something wrong with HDD ribbon.
- Seagate DB35.1, DB35.2, SV35 or Maxtor 17-g has compatibility problem. Please upgrade to the latest version to solve this problem.
- Front panel error.
- Main board is damaged.

2. DVR often automatically shuts down or stops running.

There are following possibilities:

- Input voltage is not stable or it is too low.
- HDD malfunction or something wrong with the ribbon.
- Button power is not enough.
- Front video signal is not stable.
- Working environment is too harsh, too much dust.
- Hardware malfunction.

3. System can not detect hard disk.

There are following possibilities:

- HDD is broken.
- HDD ribbon is damaged.
- HDD cable connection is loose.
- Main board SATA port is broken.

4. There is no video output whether it is one-channel, multiple-channel or all-channel output.

There are following possibilities:

- Program is not compatible. Please upgrade to the latest version.
- Brightness is 0. Please restore factory default setup.
- There is no video input signal or it is too weak.
- Check privacy mask setup or your screen saver.
- DVR hardware malfunctions.

5. Real-time video color is distorted.

There are following possibilities:

- When using BNC output, NTSC and PAL setup is not correct. The real-time video becomes black and white.
- DVR and monitor resistance is not compatible.

- Video transmission is too long or degrading is too huge.
- DVR color or brightness setup is not correct.

6. Can not search local records.

There are following possibilities:

- HDD ribbon is damaged.
- HDD is broken.
- Upgraded program is not compatible.
- The recorded file has been overwritten.
- Record function has been disabled.

7. Video is distorted when searching local records.

There are following possibilities:

- Video quality setup is too low.
- Program read error, bit data is too small. There is mosaic in the full screen. Please restart the DVR to solve this problem.
- HDD data ribbon error.
- HDD malfunction.
- DVR hardware malfunctions.

8. There is no audio when monitor.

There are following possibilities:

- It is not a power picker.
- It is not a power acoustics.
- Audio cable is damaged.
- DVR hardware malfunctions.

9. There is audio when monitor but there is no audio when system playback.

There are following possibilities:

- Setup is not correct. Please enable audio function
- Corresponding channel has no video input. Playback is not continuous when the screen is blue.

10. Time display is not correct.

There are following possibilities:

- Setup is not correct
- Battery contact is not correct or voltage is too low.
- Crystal is broken.

11. DVR can not control PTZ.

There are following possibilities:

- Front panel PTZ error
- PTZ decoder setup, connection or installation is not correct.
- Cable connection is not correct.
- PTZ setup is not correct.

- PTZ decoder and DVR protocol is not compatible.
- PTZ decoder and DVR address is not compatible.
- When there are several decoders, please add 120 Ohm between the PTZ decoder A/B cables furthest end to delete the reverberation or impedance matching. Otherwise the PTZ control is not stable.
- The distance is too far.

12. Can not log in client-end or web.

There are following possibilities:

- For Windows 98 or Windows ME user, please update your system to Windows 2000 sp4. Or you can install client-end software of lower version. Please note right now, our DVR is not compatible with Windows VISTA control.
- ActiveX control has been disabled.
- No dx8.1 or higher. Please upgrade display card driver.
- Network connection error.
- Network setup error.
- Password or user name is invalid.
- Client-end is not compatible with DVR program.

13. There is only mosaic no video when preview or playback video file remotely.

There are following possibilities:

- Network fluency is not good.
- Client-end resources are limit.
- There is multiple-cast group setup in DVR. This mode can result in mosaic. Usually we do not recommend this mode.
- There is privacy mask or channel protection setup.
- Current user has no right to monitor.
- DVR local video output quality is not good.

14. Network connection is not stable.

There are following possibilities:

- Network is not stable.
- IP address conflict.
- MAC address conflict.
- PC or DVR network card is not good.

15. USB backup error.

There are following possibilities:

- Burner and DVR are in the same data cable.
- System uses too much CPU resources. Please stop record first and then begin backup.
- Data amount exceeds backup device capacity. It may result in burner error.
- Backup device is not compatible.
- Backup device is damaged.

16. Alarm signal can not be disarmed.

There are following possibilities:

- Alarm setup is not correct.
- Alarm output has been open manually.
- Input device error or connection is not correct.
- Some program versions may have this problem. Please upgrade your system.

17. Alarm function is null.

There are following possibilities:

- Alarm setup is not correct.
- Alarm cable connection is not correct.
- Alarm input signal is not correct.
- There are two loops connect to one alarm device.

18. Remote control does not work.

There are following possibilities:

- Remote control address is not correct.
- Distance is too far or control angle is too small.
- Remote control battery power is low.
- Remote control is damaged or DVR front panel is damaged.

19. Record storage period is not enough.

There are following possibilities:

- Camera quality is too low. Lens is dirty. Camera is installed against the light. Camera aperture setup is not correct.
- HDD capacity is not enough.
- HDD is damaged.

20. Can not playback the downloaded file.

There are following possibilities:

- There is no media player.
- No DXB8.1 or higher graphic acceleration software.
- There is no DivX503Bundle.exe control when you play the file transformed to AVI via media player.
- No DivX503Bundle.exe or ffdshow-2004 1012 .exe in Windows XP OS.

21. My cell phone 3G dial failed.

There are following possibilities:

- You have not installed the dial module or your installation is not right.
- Please make sure you have inserted the card.
- You have not installed the antenna or the connection is not sound.
- The centre platform configuration is not right or the registration is not effective.
- The cell phone remaining sum is not sufficient.
- Signal is too weak.
- SIM card does not support corresponding service.

Daily Maintenance

- Do not allow other objects falling into the DVR (such as water), it may result in device malfunction.
- Always follow the transportation instructions. Do not transport the DVR upside down.
- Please pay attention to the cable connection. The improper connection steps may result in device malfunction or damage.
- Please make sure all the external cables have soundly earthed.
- Before you connect the power cable, please make sure other cables have properly connected.
- Use the cable strap in case there is short circuit, electric shock.
- Please keep the power cable neat in case it obstacles the driver or the passenger.
- Please remove the negative end (-) of the connection terminal before you configure the cable.
- Please unlock the key before you draw out the HDD box. Otherwise it may result in device damage.
- When washing the vehicle, please keep the DVR away from the water. Otherwise it may result in short circuit, fire or device malfunctions.
- Please make sure the DVR is away from the direct sunlight or other heating sources. Please keep the sound ventilation.
- Please use the brush to clean the board, socket connector and the chassis regularly.
- The DVR shall be soundly earthed in case there is audio/video disturbance. Keep the DVR away from the static voltage or induced voltage.
- Please unplug the power cable when you remove the audio/video signal cable, RS232 or RS485 cable.
- Please check the DVR is secured firmly and horizontally. Please make sure the anti-vibration component can work properly.
- Please check and maintain the DVR regularly.

8 Appendix A HDD Capacity Calculation

Calculate total capacity needed by each device according to video recording (video recording type and video file storage time).

Step 1: According to Formula (1) to calculate storage capacity q_i that is the capacity of each channel needed for each hour, unit Mbyte.

$$q_i = d_i \div 8 \times 3600 \div 1024 \quad (1)$$

In the formula: d_i means the bit rate, unit Kbit/s

Step 2: After video time requirement is confirmed, according to Formula (2) to calculate the storage capacity m_i , which is storage of each channel needed unit Mbyte.

$$m_i = q_i \times h_i \times D_i \quad (2)$$

In the formula:

h_i means the recording time for each day (hour)

D_i means number of days for which the video shall be kept

Step 3: According to Formula (3) to calculate total capacity (accumulation) q_T that is needed for all channels in the device during **scheduled video recording**.

$$q_T = \sum_{i=1}^c m_i \quad (3)$$

In the formula: c means total number of channels in one device

Step 4: According to Formula (4) to calculate total capacity (accumulation) q_T that is needed for all channels in device during **alarm video recording**.

$$q_T = \sum_{i=1}^c m_i \times a\% \quad (4)$$

In the formula: $a\%$ means alarm occurrence rate

9 Appendix B Compatible SATA HDD

Manufacturer	Series	Model	Capacity	Port Mode
Hitachi	CINEMASTAR series for DVR use	HCC545025B9A300	250GB	SATA
Hitachi	CINEMASTAR series for DVR use	HCC545016B9A300	160GB	SATA
Hitachi	5K500.B laptop series	HTS545025B9A300	250GB	SATA
Hitachi	5K500.B laptop series	HTS545016B9A300	160GB	SATA
Hitachi	5K500.B laptop series	HTS545012B9A300	120GB	SATA

Appendix C Toxic or Hazardous Materials or Elements

Component Name	Toxic or Hazardous Materials or Elements					
	Pb	Hg	Cd	Cr VI	PBB	PBDE
Sheet Metal(Case)	○	○	○	○	○	○
Plastic Parts (Panel)	○	○	○	○	○	○
Circuit Board	○	○	○	○	○	○
Fastener	○	○	○	○	○	○
Wire and Cable/Ac Adapter	○	○	○	○	○	○
Packing Material	○	○	○	○	○	○
Accessories	○	○	○	○	○	○

Note

O: Indicates that the concentration of the hazardous substance in all homogeneous materials in the parts is below the relevant threshold of the SJ/T11363-2006 standard.

X: Indicates that the concentration of the hazardous substance of at least one of all homogeneous materials in the parts is above the relevant threshold of the SJ/T11363-2006 standard. During the environmental-friendly use period (EFUP) period, the toxic or hazardous substance or elements contained in products will not leak or mutate so that the use of these (substances or elements) will not result in any severe environmental pollution, any bodily injury or damage to any assets. The consumer is not authorized to process such kind of substances or elements, please return to the corresponding local authorities to process according to your local government statutes.

Note

- This manual is for reference only. Slight difference may be found in the user interface.
- All the designs and software here are subject to change without prior written notice.
- All trademarks and registered trademarks are the properties of their respective owners.
- If there is any uncertainty or controversy, please refer to the final explanation of us.
- Please visit our website or contact your local service engineer for more information.